

LDP135-151

All-in-One Direct View LED Display User Guide

IMPORTANT: Please read this User Guide to obtain important information on installing and using your product in a safe manner, as well as registering your product for future service. Warranty information contained in this User Guide will describe your limited coverage from ViewSonic® Corporation, which is also found on our web site at <http://www.viewsonic.com> in English, or in specific languages using the Regional selection box in the upper right corner of our website.

Model No. VS18884
P/N: LDP135-151

Thank you for choosing ViewSonic®

As a world-leading provider of visual solutions, ViewSonic® is dedicated to exceeding the world's expectations for technological evolution, innovation, and simplicity. At ViewSonic®, we believe that our products have the potential to make a positive impact in the world, and we are confident that the ViewSonic® product you have chosen will serve you well.

Once again, thank you for choosing ViewSonic®!

Safety Precautions

Please read the following **Safety Precautions** before you start using the device.

- Keep this user guide in a safe place for later reference.
- Read all warnings and follow all instructions.
- Ensure there is no direct airflow from air conditioning blowing on the display.
- Do not use the device near water. To reduce the risk of fire or electric shock, do not expose the device to moisture.
- Avoid exposing the device to direct sunlight or other sources of sustained heat.
- Do not install near any heat sources such as radiators, heat registers, stoves, or other devices (including amplifiers) that may increase the temperature of the device to dangerous levels.
- When moving the device, be careful not to drop or bump the device on anything.
- Do not place the device on an uneven or unstable surface. The device may fall over resulting in an injury or a malfunction.
- Do not place any heavy objects on the device or connection cables.
- If smoke, an abnormal noise, or a strange odor is present, immediately turn the device off and call your dealer or ViewSonic®. It is dangerous to continue using the device.
- Do not attempt to circumvent the safety provisions of the polarized or grounding-type plug. A polarized plug has two blades with one wider than the other. A grounding-type plug has two blades and a third grounding prong. The wide blade and the third prong are provided for your safety. If the plug does not fit into your outlet, obtain an adapter and do not attempt to force the plug into the outlet.
- When connecting to a power outlet, DO NOT remove the grounding prong. Please ensure grounding prongs are NEVER REMOVED.
- Protect the power cord from being treaded upon or pinched, particularly at the plug, and at the point where it emerges from the equipment. Ensure that the power outlet is located near the equipment so that it is easily accessible.
- Only use attachments/accessories specified by the manufacturer.
- When a cart is used, use with caution when moving the cart/equipment combination to avoid injury from tipping over.
- Disconnect the power plug from the AC outlet if the device is not being used for a long period of time.

- Place the device in a well-ventilated area.
- Do not cover the surface of the display with any material.
- Do not block the air circulation around the display.
- Keep flammable materials away from the display.
- Refer all servicing to qualified service personnel. Service will be required when the unit has been damaged in any way, such as:
 - » if the power supply cord or plug is damaged;
 - » if liquid is spilled onto or objects fall in the unit;
 - » if the unit is exposed to moisture;
 - » if the unit does not operate normally or has been dropped.
- Do not assemble the display by yourself.
- This panel is an advanced product that contains millions of pixels. You may occasionally see pixel spots when viewing the screen. Since these deactivated pixels are not a defect, the performance and reliability of the product is not affected. For more information, please see page 136.

Contents

Safety Precautions.....	3
Introduction	9
Package Contents	9
Product Overview	11
Front Panel	11
Rear Panel	11
I/O Ports	12
Control Panel.....	13
Remote Control	14
Installation	17
Before Installing.....	17
Wall Mounting.....	17
Installing the Cabinets	19
Connecting the System Control Box	22
Installing the LED Modules	25
Installing System Control Box Covers	26
Floor Stand Installation.....	28
Component List	28
Dimensions.....	29
Constructing the Floor Stand	30
Connecting the System Control Box to the Floor Base.....	32
Installing the Middle Cabinets.....	33
Installing the Left and Right Cabinet	36
Connect the Network and Power Cables	37
Installing the LED Modules	38
Installing System Control Box Covers	39
Detachable System Control Box	41
Wall Mounting.....	41
Installing the Cabinets.....	44
Connecting the System Control Box (Hidden Installation)	47
Installing the LED Modules.....	49





Dual-Screen Splicing	50
Wall Mounting.....	51
Installing the Cabinets.....	53
Connecting the System Control Box (Standard Installation)	56
Connecting the System Control Box (Hidden Installation)	60
Installing the LED Modules	63
Portrait Mode	65
Wall Mounting.....	66
Installing the Cabinets.....	67
Connecting the System Control Box (Standard Installation)	72
Connecting the System Control Box (Hidden Installation)	76
Installing the LED Modules	78
Making Connections	80
Connecting to External Devices	80
HDMI IN Connection	80
Audio Connection.....	80
HDBaseT Connection	80
Video Output Connection	81
USB and Networking Connections	81
RS-232 Connection	82



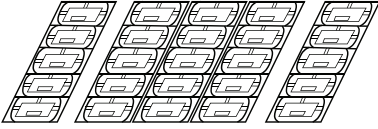

Using Your Display.....	83
Powering On/Off your LED Display	83
Home Screen	84
Navigating the Home Screen	85
Remote Control	85
Keyboard and Mouse	85
APP Center.....	86
Input Source	87
Settings.....	88
Settings Menu Tree	89
Network & Internet.....	94
Connected Devices.....	96
Apps	97
Display	99
Sound	103
Storage	104
System.....	105
Upgrade.....	109
On-Screen Display (OSD) Menu	110
On-Screen Display (OSD) Menu Tree	111
Menu Options	113
Color Mode	113
Display Mode	114
Advanced Mode	120
Speaker	122
PIP/PBP Mode.....	124
Information.....	127
Embedded Applications.....	128
ViewBoard Cast	128
Browser	132
vSweeper	133
WPS Office.....	134

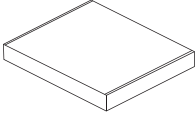
Appendix.....	135
Specifications.....	135
LED Display Stuck Pixel Definition	136
Timing Chart	137
HDMI (PC).....	137
HDMI (Video).....	138
Supported Media Formats.....	139
Troubleshooting	141
Maintenance.....	143
General Precautions.....	143
Initial Operation	143
Front Panel Cleaning Instructions	143
Cabinet Cleaning Instructions	143
Regular Use	144
Vacuum Suction Tool.....	145
LED Module Disassembly	147
RS-232 Protocol.....	149
RS-232 Hardware Specification	149
RS-232 Communication Setting.....	149
Command Table	150
Regulatory and Service Information	151
Compliance Information.....	151
FCC Compliance Statement.....	151
IC Warning Statement	152
Country Code Statement.....	152
IC Radiation Exposure Statement.....	153
CE Conformity for European Countries	153
Declaration of RoHS2 Compliance.....	154
European Union Regulatory Conformance	154
Indian Restriction of Hazardous Substances	155
Product Disposal at End of Product Life	155
Copyright Information	156
Customer Service	157
Limited Warranty	158
Mexico Limited Warranty.....	161

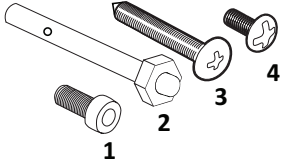
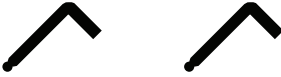
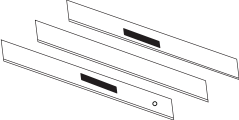
Introduction

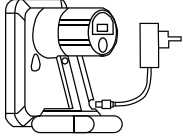
Package Contents

Item	Quantity	Note
Cabinet Sections		5 sections total One (1) Left, three (3) Middle, and one (1) Right.
System Control Box (Left and Right sides)		2 sides
Quick Start Guide		1
LED Modules		100 modules The quantity of spare LED modules will vary by country.
Remote Control		1
Screws		20 x M6x10mm (1) 32 x M6x50mm Expansion (2) 32 x TA6x30mm (3) 12 x KM3x6mm (4)
Hex Tool (Allen wrench)		2 1 x 5 mm 1 x 8 mm
System Control Box Covers (Left, Middle, and Right sides)		3

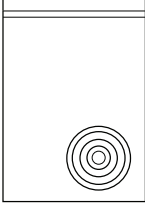
Item	Quantity	Note
Wall Mounting Brackets		4
Vacuum Suction Tool		1
Anti-Static Gloves		2 pairs
LAN Cable (5m)		1
IR Extender Cable (3m)		1
Bag with LEDs		<p>1 bag (1,000 pieces)</p> <p>Replacement LED beads specific to module batch number.</p> <p>Cannot be used on different LED module batch(es).</p>

NOTE:

- This product is packed in an air transport box.
- Due to the size and weight, it is recommended that two or more people handle it.
- The base stand is an optional accessory and will be sold separately.

Product Overview

Front Panel

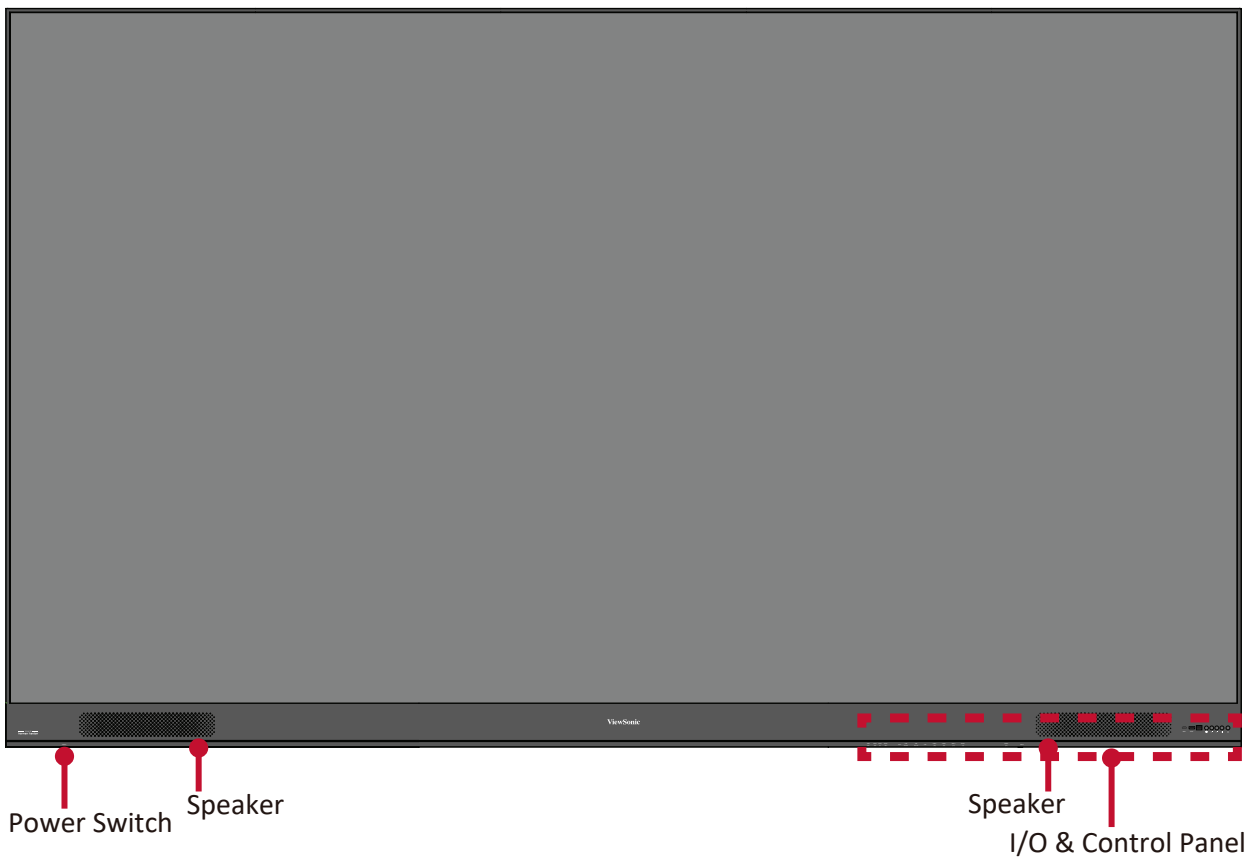



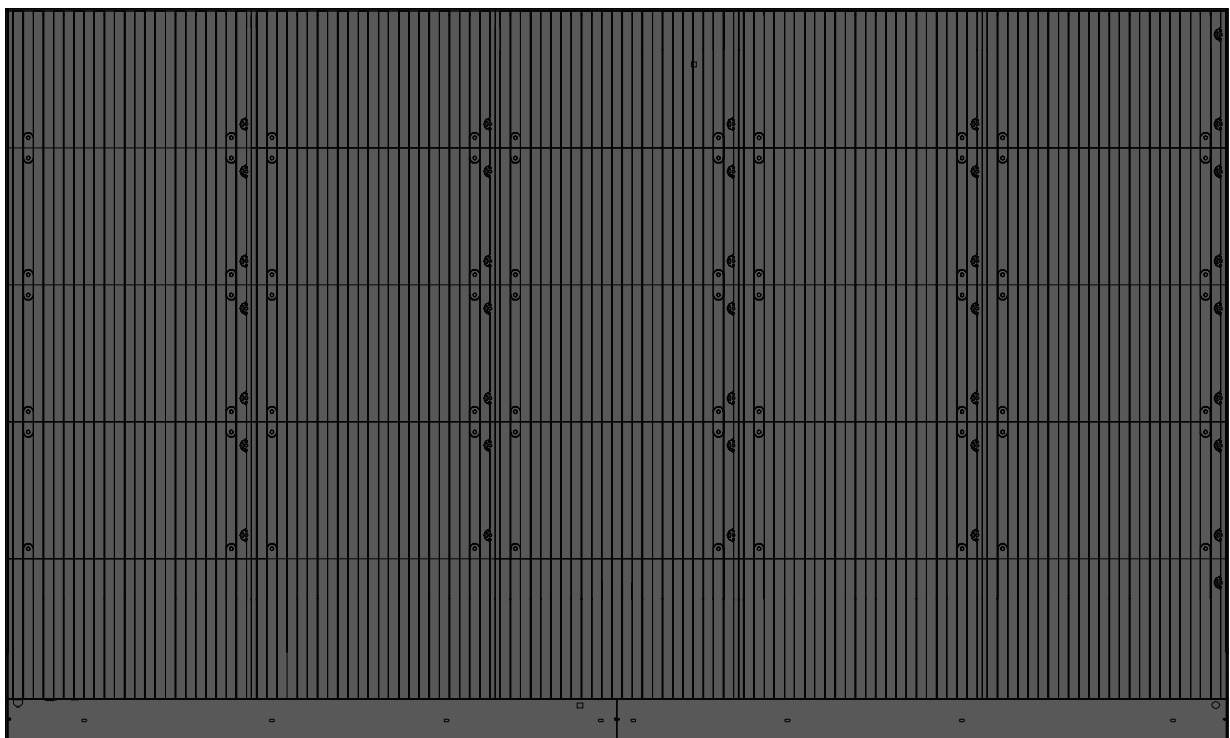



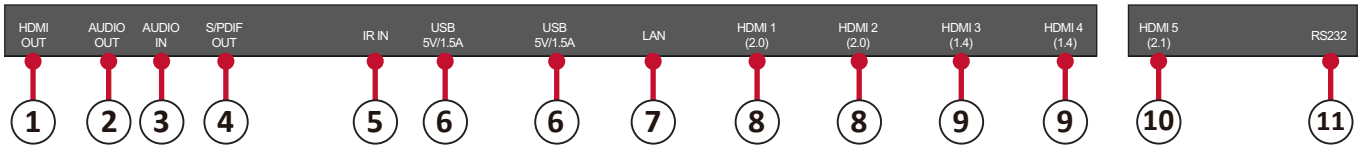



Rear Panel







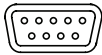

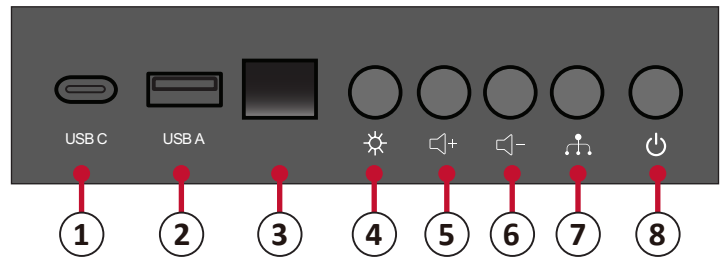

I/O Ports



Number	Item	Port	Description
1		HDMI OUT	Extend content out to another display device.
2		Audio OUT	Audio output to an external speaker.
3		Audio IN	Audio input from an external device.
4		S/PDIF Out	Multichannel sound via optical signals.
5		IR IN	Extend the IR Receiver.
6		USB 2.0	USB Reader (5V/1.5A).
7		LAN	Standard RJ45 (10M/100M/1000M) Internet connection interface.
8		HDMI IN 2.0	High definition input: PIP/PBP ,connect to PC with HDMI output, set-top box, or other video device.
9		HDMI IN 1.4	High definition input: PIP/PBP ,connect to PC with HDMI output, set-top box, or other video device.
10		HDMI IN 2.1	High definition input: connect to PC with HDMI output, set-top box, or other video device.
11		RS-232	Serial control port.

Control Panel



Number	Item	Description
1	 USB C	USB-C Reader (5V/2A)
2	 USB 2.0	USB Reader (5V/1.5A)
3	 IR Receiver	Receiver for the Remote Control.
4	 Brightness	Press to cycle through brightness levels.
5	 Volume +	Increase the volume.
6	 Volume -	Decrease the volume.
7	 Input Select	Press to cycle through available input sources.
8	 Stand-by	Press to enter Stand-by mode.

Locking the Control Panel

When the administrator does not want others to use the control panel, it can be locked by pressing 1168+OK on the remote control.

Remote Control

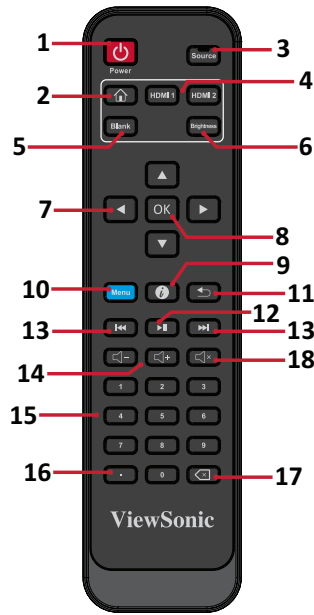

Number	Icon	Item	Description
1		Power	Power On/Off
2		Home	Back to Home Screen
3		Source	Input source selection
4		HDMI 1/2	Change to HDMI 1/2 input source
5		Blank	Switch to a blank, black screen
6		Brightness	Adjust the brightness level
7		▲/▼/◀/▶	Directional buttons
8		OK	Confirm the selection
9		i	Enter the Information page
10		Menu	Enter the Settings menu
11		Return	Return to previous
12		Play/Pause	Play/Pause content
13		Forwards/Backwards	Move content forwards/backwards
14		Volume Up/Down	Increase/decrease the volume level
15		Numbers	Numeric input buttons
16		.	Input key for a dot
17		Backspace/Clear	Delete key for text input
18		Mute	Mute/Unmute

Inserting Remote Control Batteries

The remote control is powered by two 1.5V "AAA" batteries.

To insert batteries into the remote control:

1. Remove the cover on the rear of the remote control.
2. Insert two "AAA" batteries, ensuring the "+" symbol on the battery matches the "+" on the battery post.
3. Replace the cover by aligning it with the slot on the remote control and snapping the latch shut.

WARNING: There is a risk of explosion if batteries are installed with incorrect polarity.

NOTE:

- It is recommended that you do not mix battery types.
- Avoid exposure to heat or steam.
- Do not allow water or other liquids to splash on the remote control. If the remote control becomes wet, wipe it dry immediately.
- Always dispose of old batteries in an environmentally friendly way. Contact your local government for more information on how to dispose of batteries safely.

Locking the Remote Control

When the administrator does not want others to control the remote control, it can be locked by pressing 1169+OK on the remote control.

Remote Control Receiver Range

The operating range of the remote control is shown here. It has an effective range of 20 feet (6 meters), 30° degrees left and right. Ensure there is nothing obstructing the remote control's signal to the receiver.

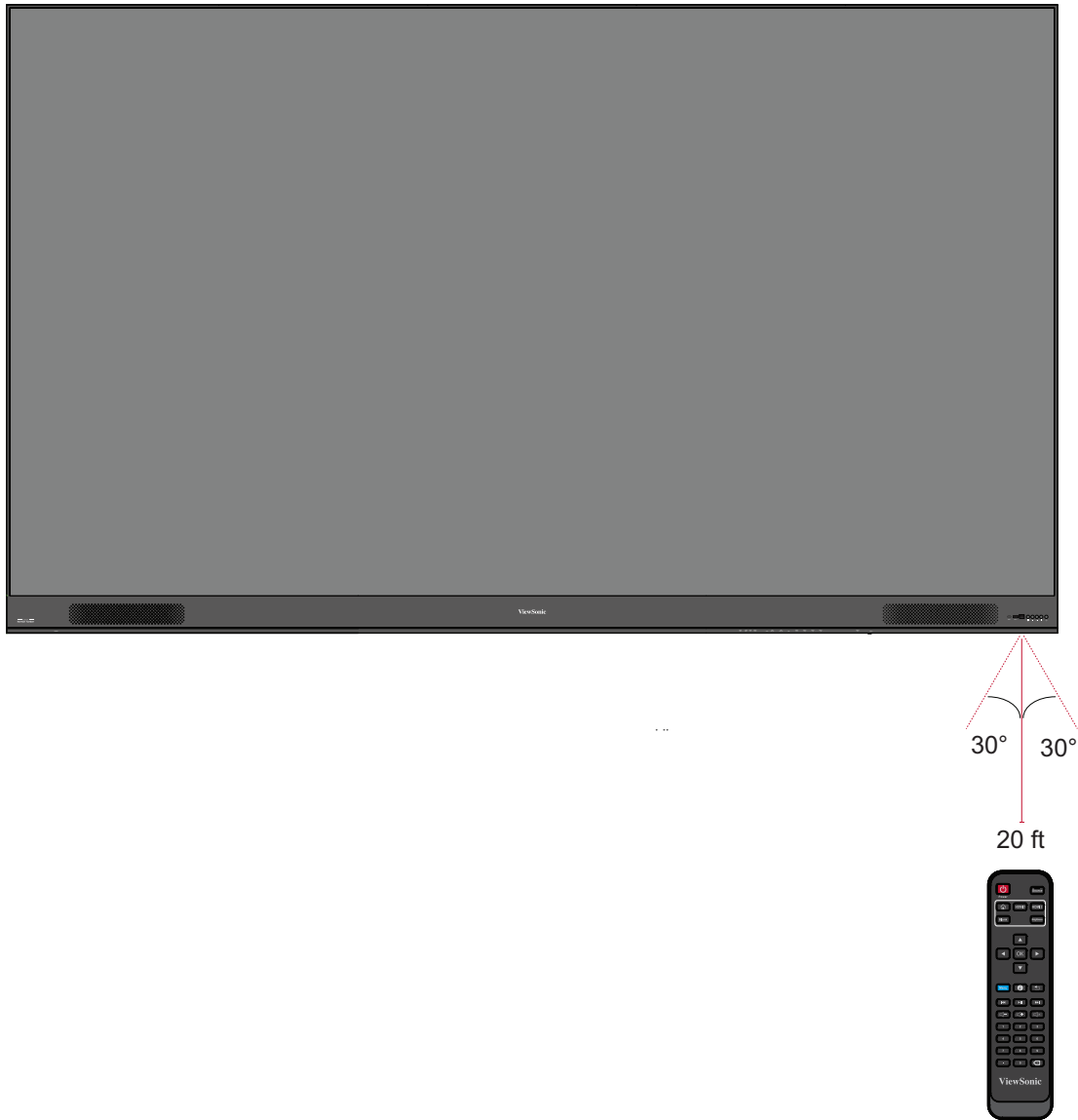

Installation

Before Installing

- ❗ Maintain an adequate air gap between the back of the display and any wall for proper ventilation.
- ❗ Ensure there is no direct airflow from air conditioning or heating vents blowing on the display.
- ❗ Avoid installing the display in places with high humidity.
- ❗ Due to high power usage, always use power cords specifically designed for this product.

Wall Mounting

Installing the Upper and Lower Wall Mount Brackets

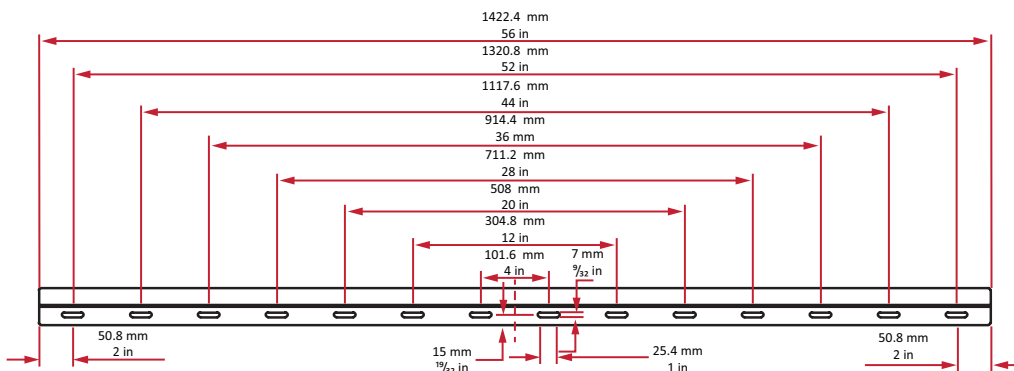

1. Ensure the wall area and size is an appropriate installation site.
NOTE: The height of the Upper *Wall Mount Brackets* must not be less than 90 ³⁵/₆₄" (2300 mm) from the ground.
2. Using the *Wall Mount Bracket* (pictured above) as a guide, mark at least eight (8) holes and pre-drill them.
3. Install the first Upper *Wall Mount Bracket* with the provided screws (M6x50mm Expansion for masonry; TA6x30mm for load bearing wood).
4. Repeat **Step 2**, ensuring the second Upper *Wall Mount Bracket* is level with the first upper bracket. Keep a 3 ¹¹/₃₂" (85 mm) space between the two brackets.

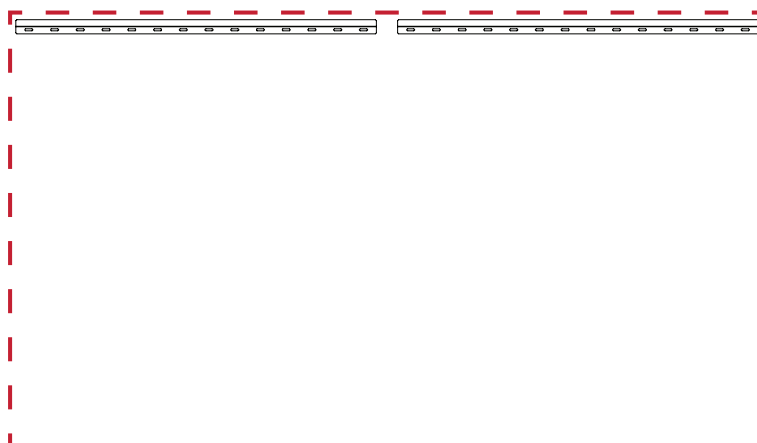

5. Install the Lower *Wall Mount Brackets* in the same manner as the Upper *Wall Mount Brackets*. The distance between the Upper and Lower *Wall Mount Brackets* is 53 ⁵/₃₂" (1350 mm).

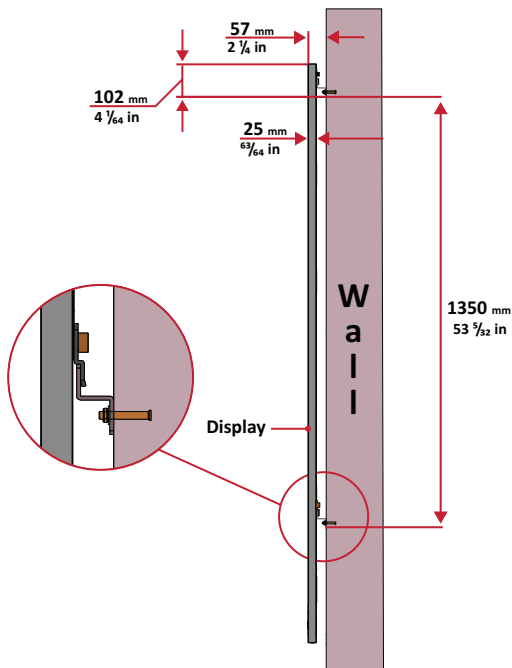

NOTE: You can also install the Upper *Wall Mount Brackets*, hang the screen, and then install the Lower *Wall Mount Brackets* for a more precise fit.

- ❗ Ensure the wall can safely support 297.62 lbs. (135 kg).
- ❗ Ensure the deviation of the wall surface is < ¹³/₆₄" (< 5mm).

6. After installing both Upper and Lower *Wall Mount Brackets*, the installation wall should look like:

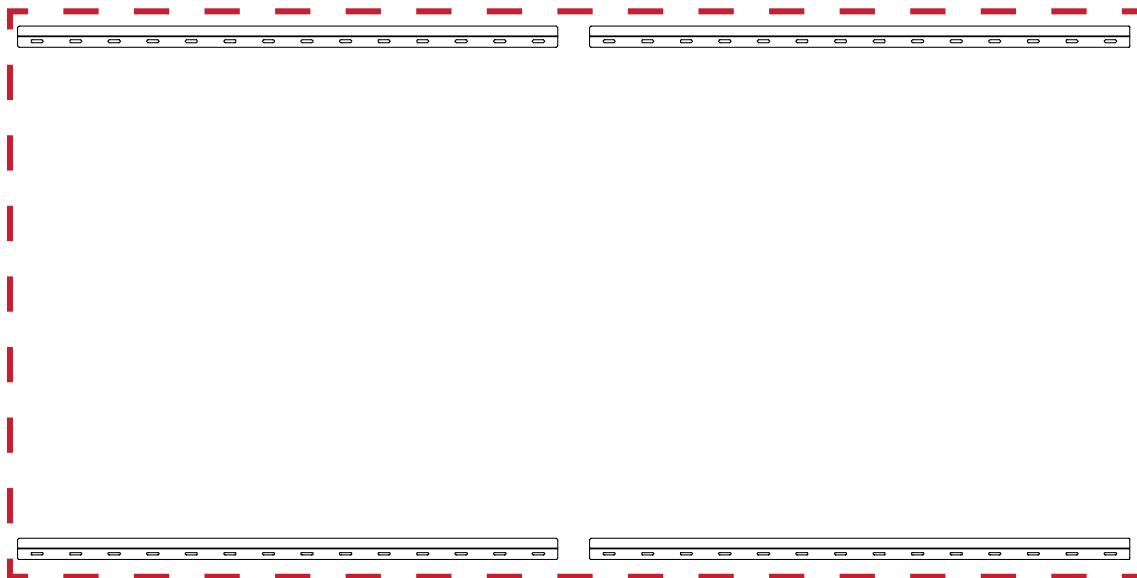

Installing the Cabinets

1. Ensure the *Mounting Brackets* on the rear of the five (5) Middle Cabinets are positioned at the top and bottom mounting positions as shown below:

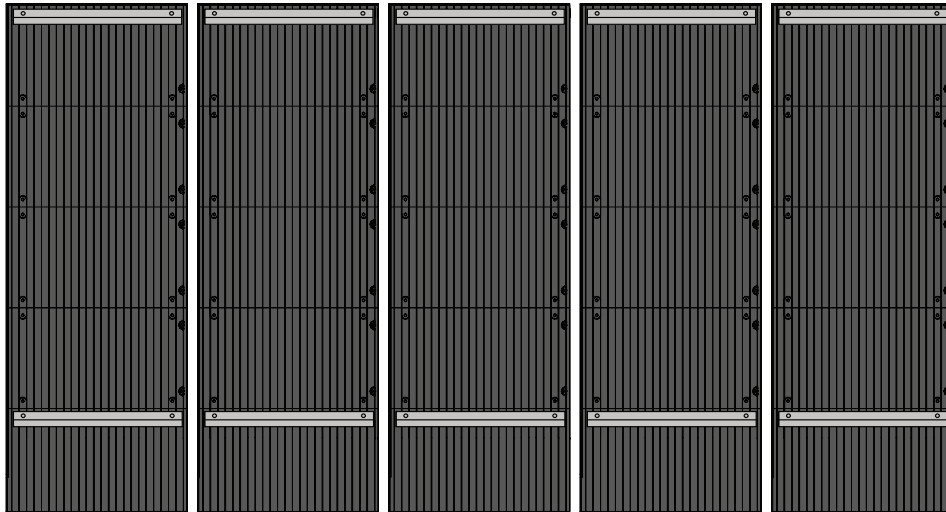

2. Carefully lift each *Cabinet* up onto the *Upper Wall Mount Brackets*, starting from the left.

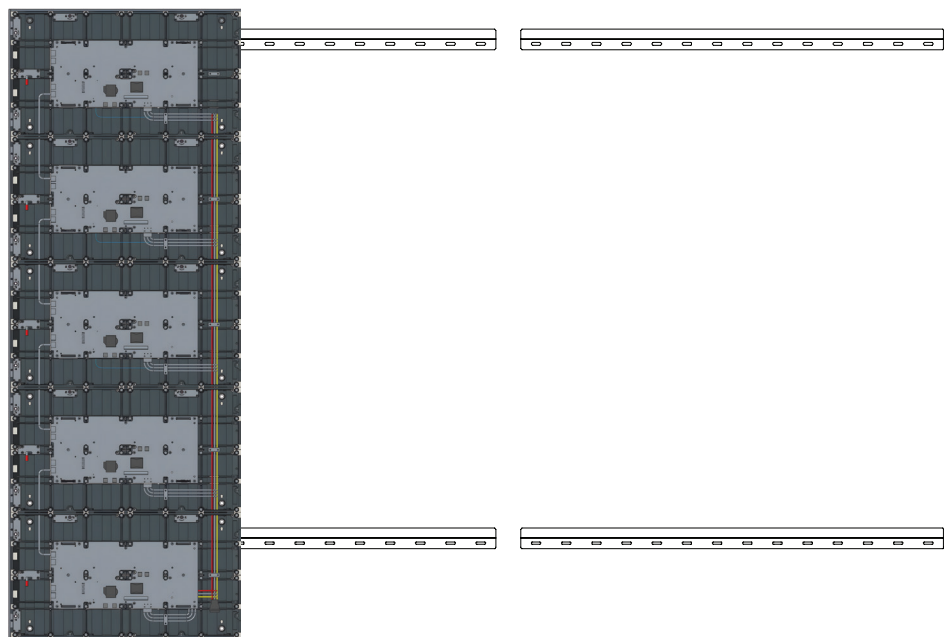

3. Ensure the *Mounting Brackets* sit securely on the *Wall Mount Brackets* as shown below.

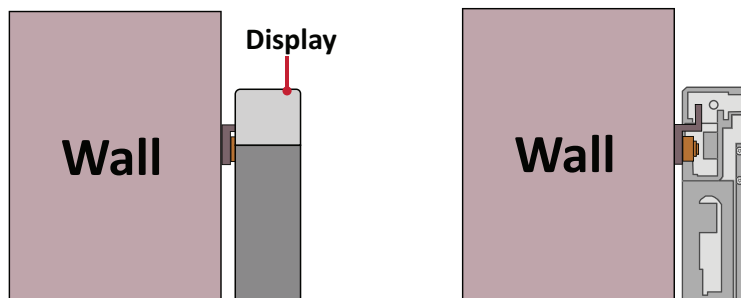

4. Push each *Locking Bolt* and lock each *Hook* with the hex tool to securely connect each cabinet together. It may be necessary to align the hole with an Allen wrench in order to engage the *Locking Bolt*.

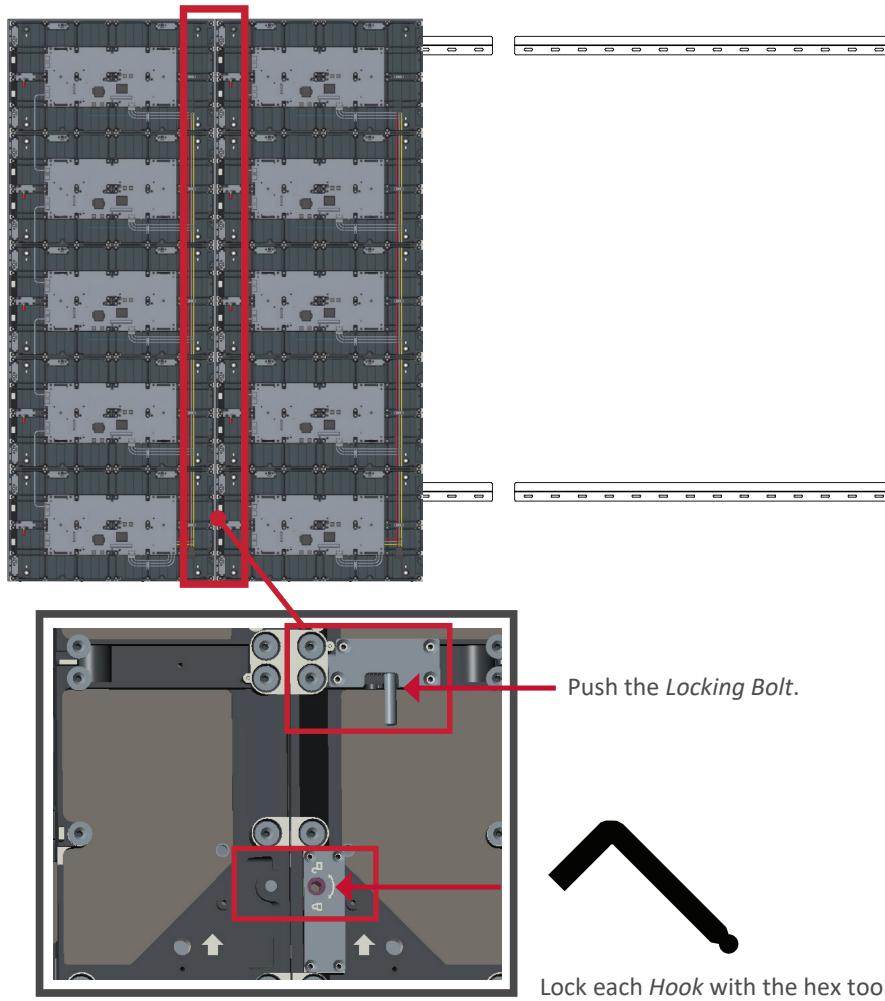

NOTE: There are five (5) *Locking Bolts* and 10 *Hooks* between each cabinet.

5. Place the remaining *Cabinets* up onto the *Upper Wall Mount Brackets*. Install from left to right, ensuring the *Mounting Brackets* sit securely on the *Wall Mount Brackets*.
6. Repeat **Step 4**, securing the cabinets together with each *Locking Bolt* and *Hook*.

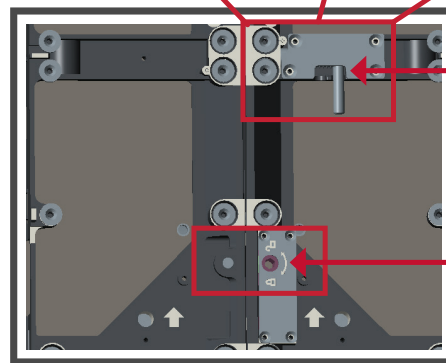
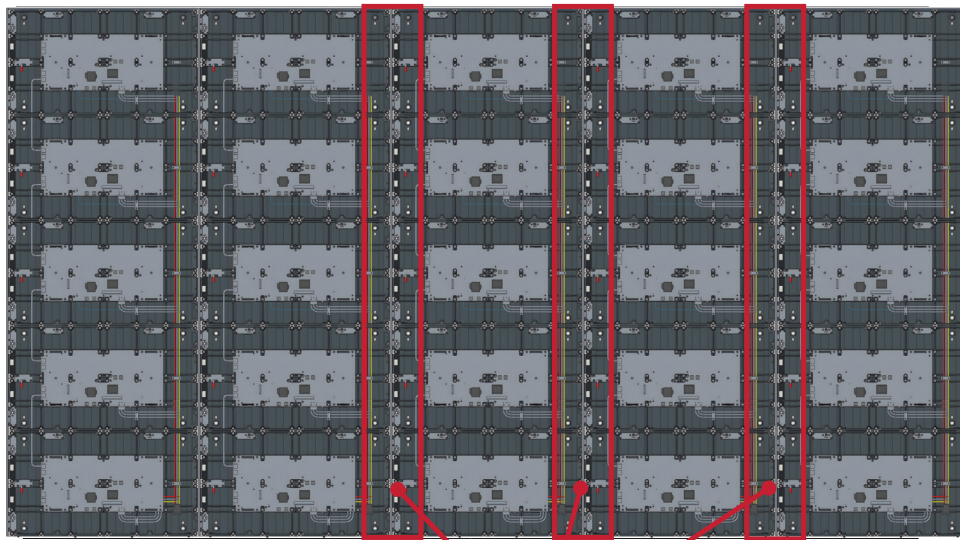

Push the *Locking Bolt*.



Lock each *Hook* with the hex tool.

NOTE: There are five (5) *Locking Bolts* and 10 *Hooks* between each cabinet.

Connecting the System Control Box

1. Carefully unfold the *System Control Box* panel. Ensure the main system control board is on the right.

NOTE: Use caution as the *System Control Box* panel is separated into two pieces with wires attached.

2. Align the holes of the *Cabinet* with the *System Control Box* to attach.

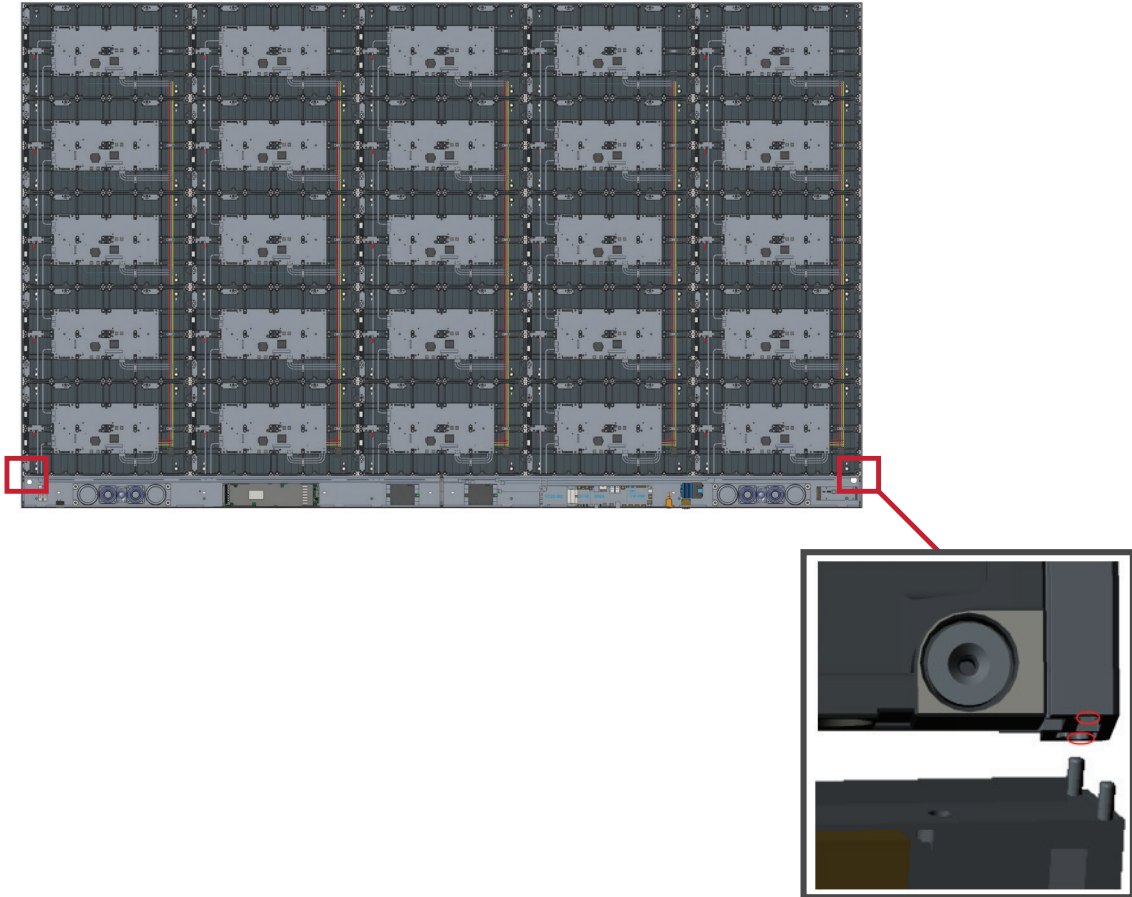

3. You can also reroute the power cable for cable management. Loosen the two (2) PWM 4x6mm screws, pull the power cable out, thread the power cable through the hole and then fasten the screws tightly.

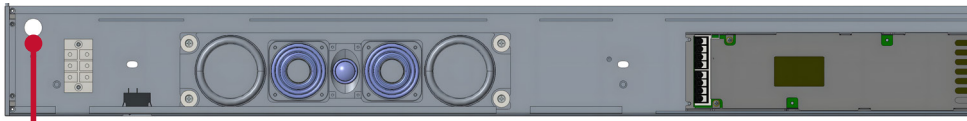

Hole for cable management

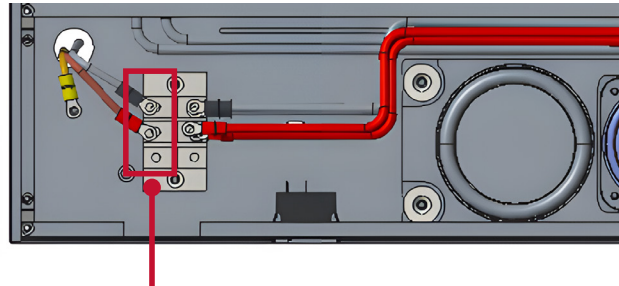

Two (2) PWM 4x6mm Screws

! Professional installation only.

4. Further secure the *System Control Box* to the *Cabinets* with the 20 provided M6x10mm screws.

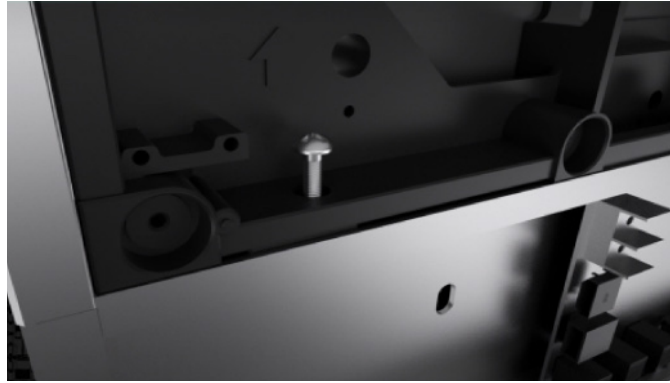

5. Connect the Network and Power cables of the *Cabinets* to the *System Control Box*.

NOTE: There are five (5) Network and five (5) Power cables to connect.

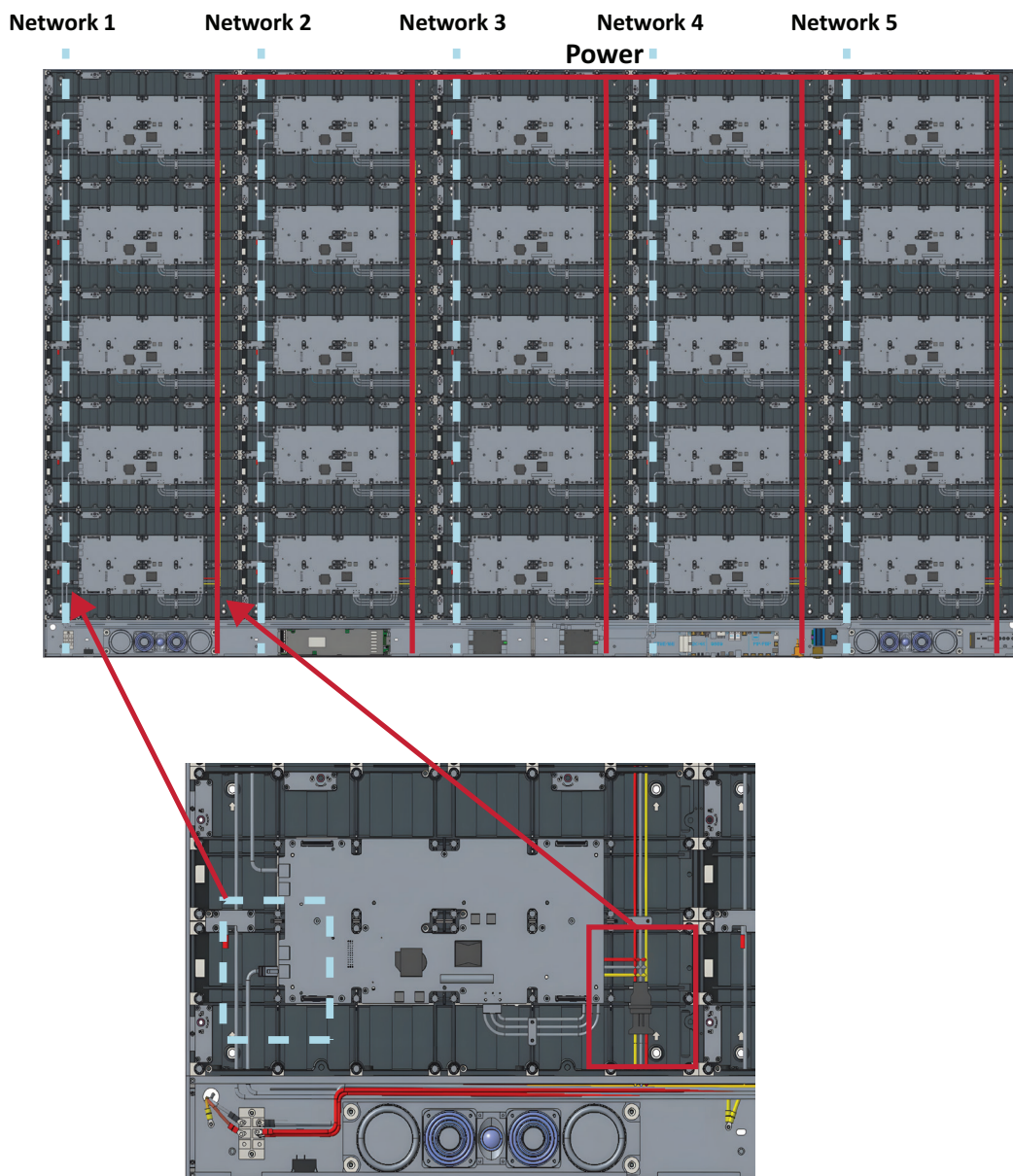

Installing the LED Modules

1. Install each *LED Module* onto the *Cabinets*, being sure to match the corresponding numbers on the *Module* to the *Cabinet*.

! Please wear Anti-Static Gloves before handling the LED modules.



2. Ensure each *Module* is flush and that there is little to no gap between each. It may be necessary to gently tap the module to make it flush.

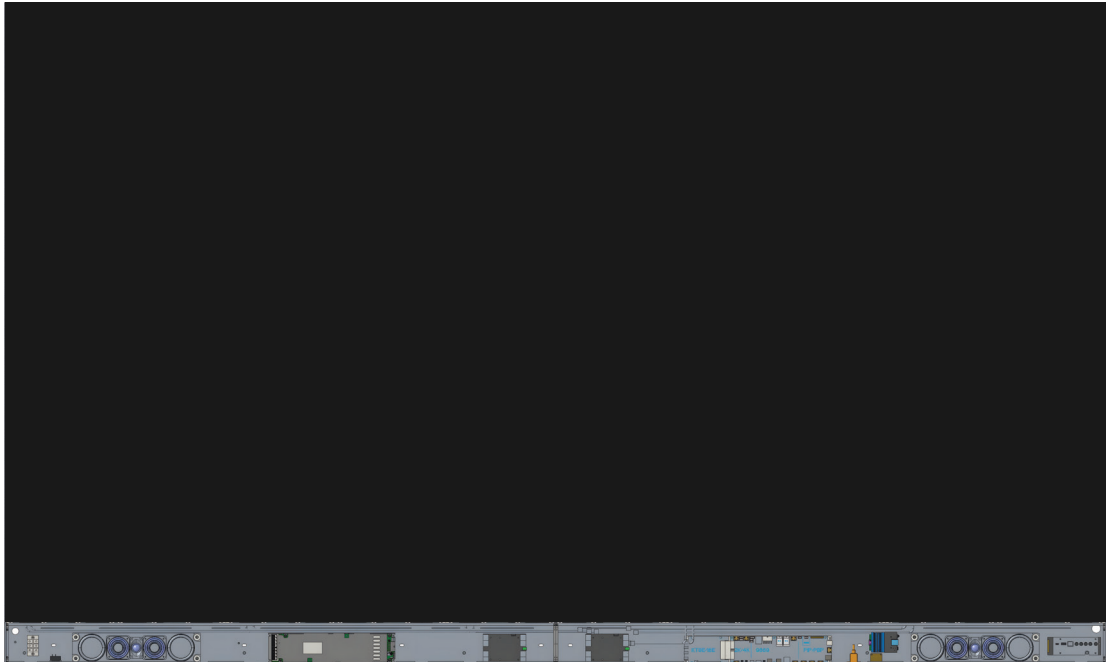

Installing System Control Box Covers

There are three (3) System Control Box Covers: Left, Middle, and Right.



1. Begin by installing the *Right Cover* onto the *System Control Box*.

NOTE: Ensure the **Power Button** cable is connected to the *System Control Box* Power cable before securing the *Cover*.

2. After connecting the **Power Button** cable, ensure the *Right Cover* is properly aligned with the *System Control Box*; then secure it with the 12 provided KM3x6mm screws.

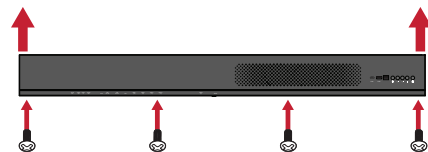
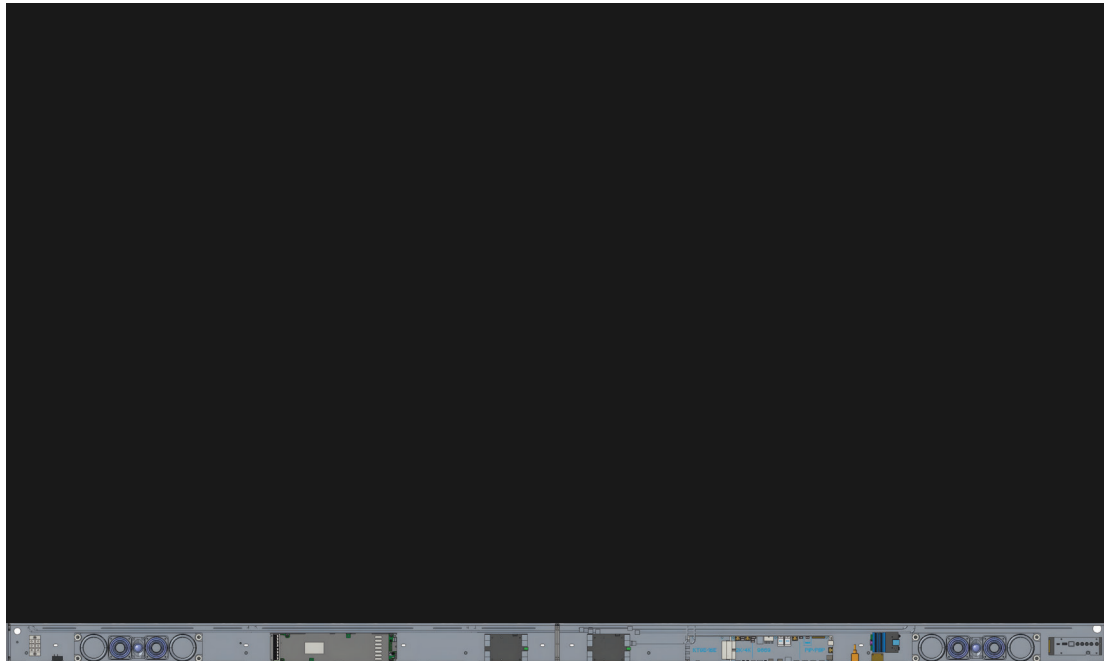

3. Repeat the above steps for the *Middle* and *Left Cover*.



4. Your display is now ready to power on.



NOTE: We also offer a variety of installation options for different scenarios: Floor Stand, Portrait Mode, Detachable Control Box, and Dual-Screen Splicing (32:9).

Floor Stand Installation

The floor stand is an optional accessory. Follow the below instructions to install your LED Display onto the stand.

Component List

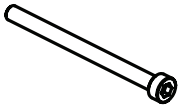
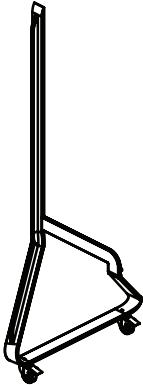
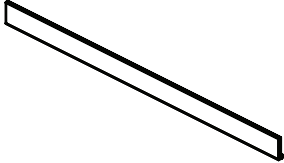
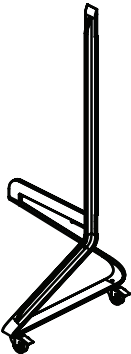
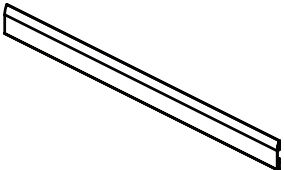
Letter	Item	Quantity	Description
A		1	Hex Tool
B		8	M6 x 80mm Bolt
C		1	Left Support
D		1	Bottom Cross Beam
E		1	Right Support
F		1	Top Cross Beam

Dimensions

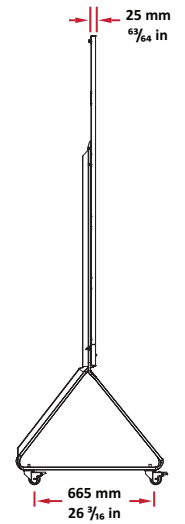
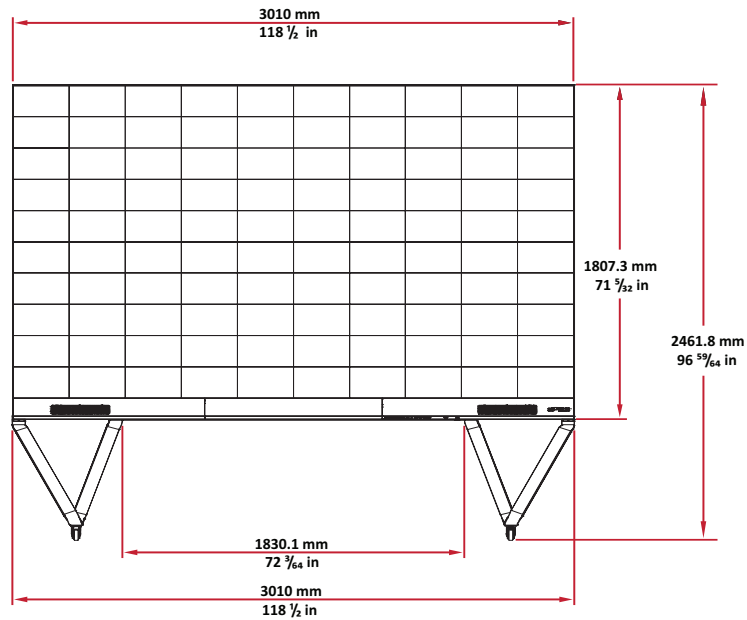
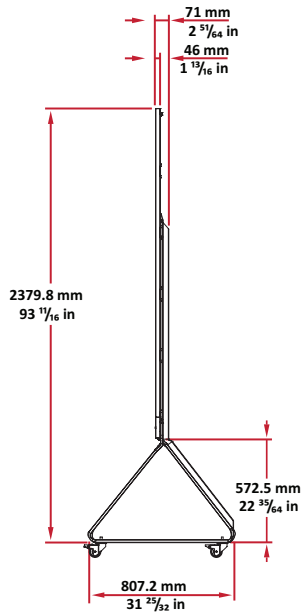
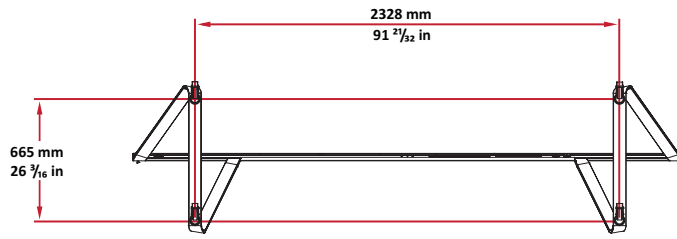

Constructing the Floor Stand

1. Connect the *Left Support* to the *Bottom Cross Beam* with two (2) M6 x 80mm bolts.

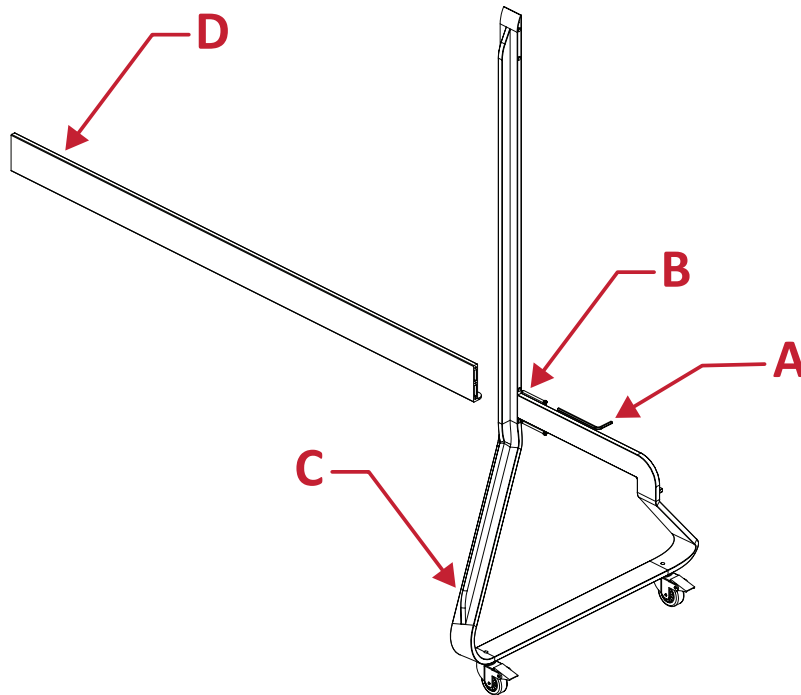

2. Connect the *Right Support* with the *Bottom Cross Beam* with two (2) M6 x 80mm bolts.

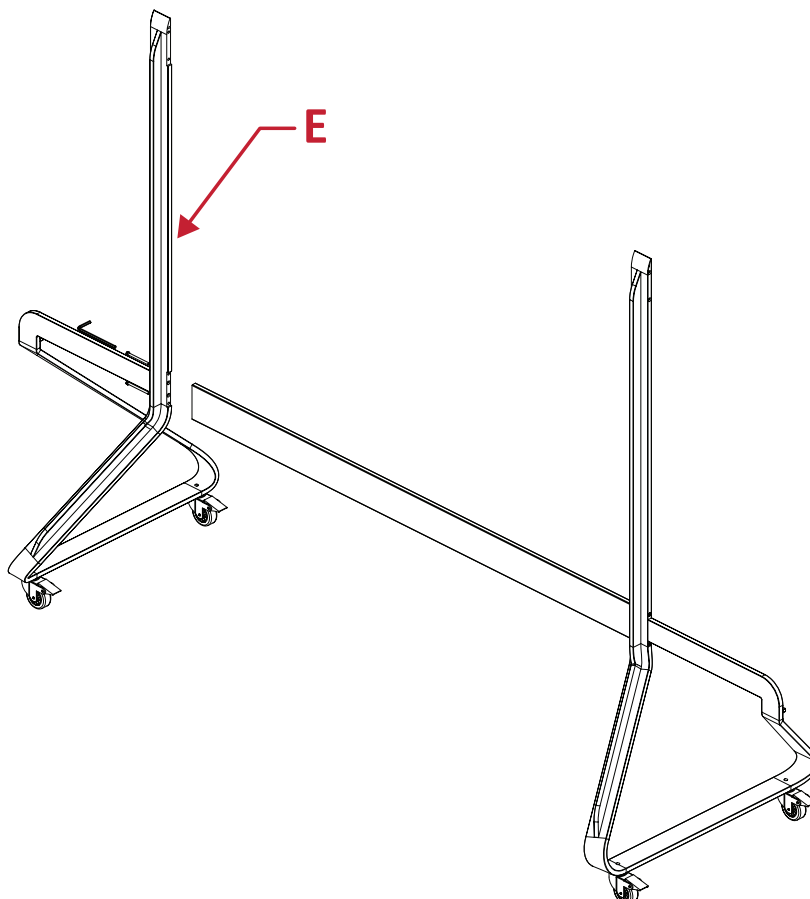

3. Connect the *Top Cross Beam* to the *Left and Right Supports* with four (4) M6 x 80mm bolts.

NOTE: Ensure the groove of the *Top Cross Beam* faces inwards.

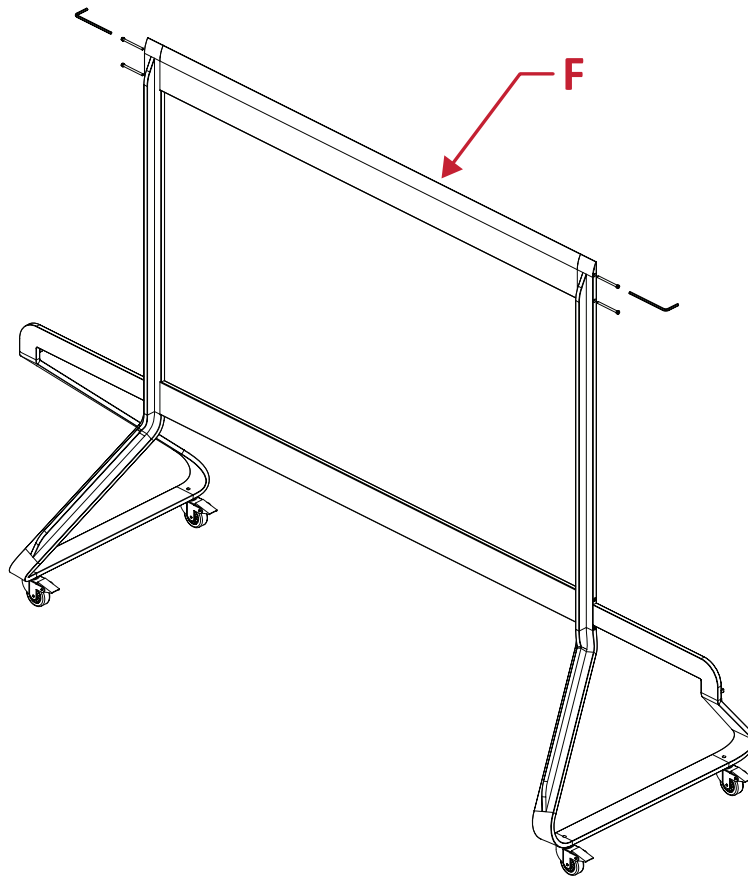

4. Ensure all bolts are tightened properly.

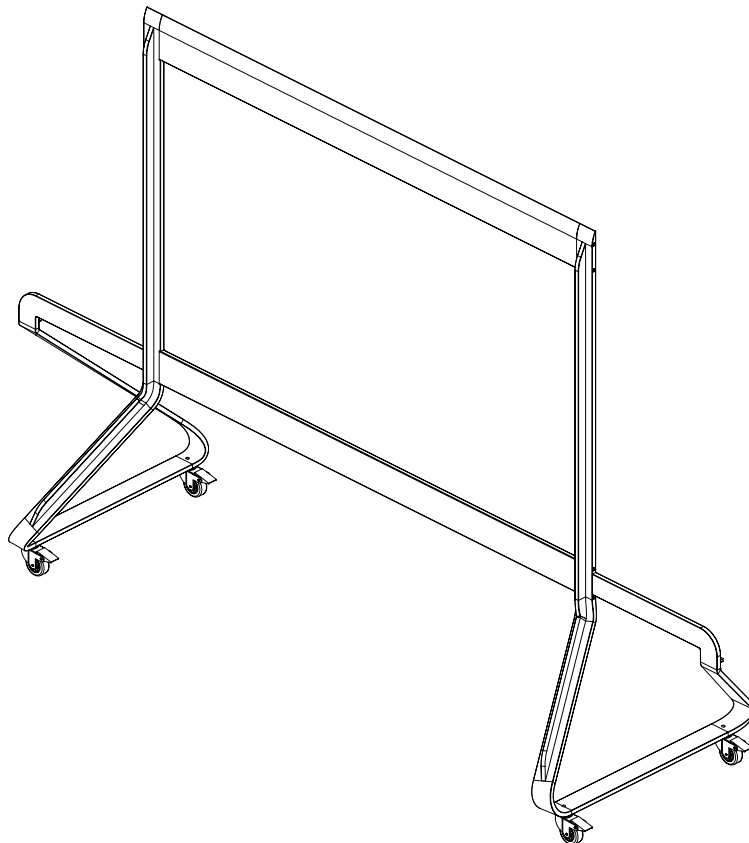

Connecting the System Control Box to the Floor Base

1. Carefully unfold the *System Control Box* panel. Ensure the main system control board is on the right.

NOTE: Use caution as the *System Control Box* panel will be separated into two pieces, however the wires are connected.

2. Align the *System Control Box* to the eight (8) holes on the *Bottom Cross Beam* and secure it with eight (8) screws (M6x10mm).

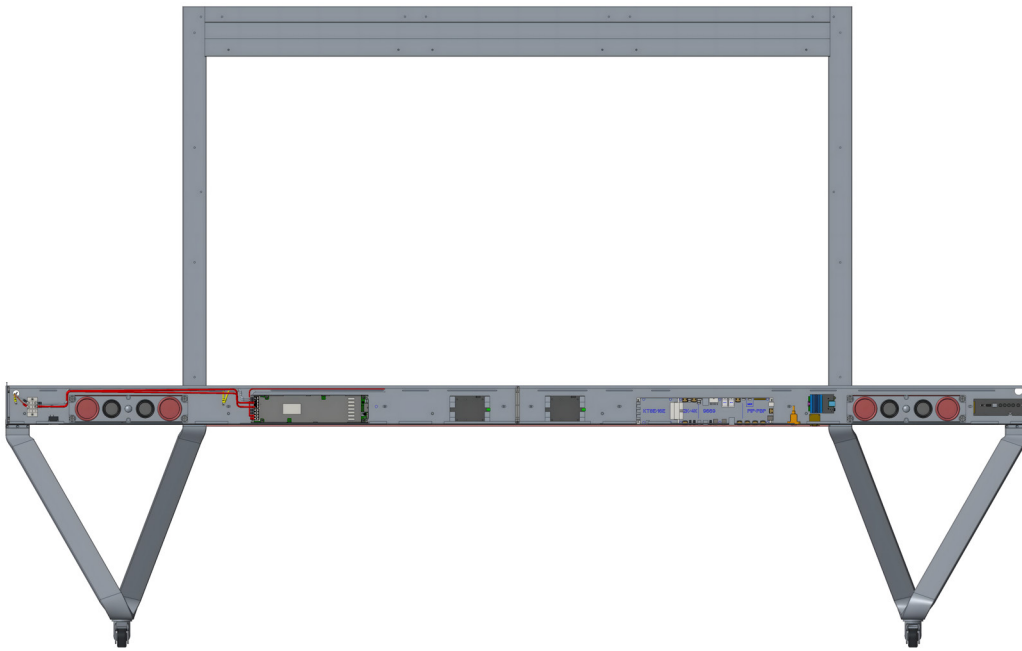

3. Install two (2) additional screws (M6x10mm) to connect the two halves of the *System Control Box*.

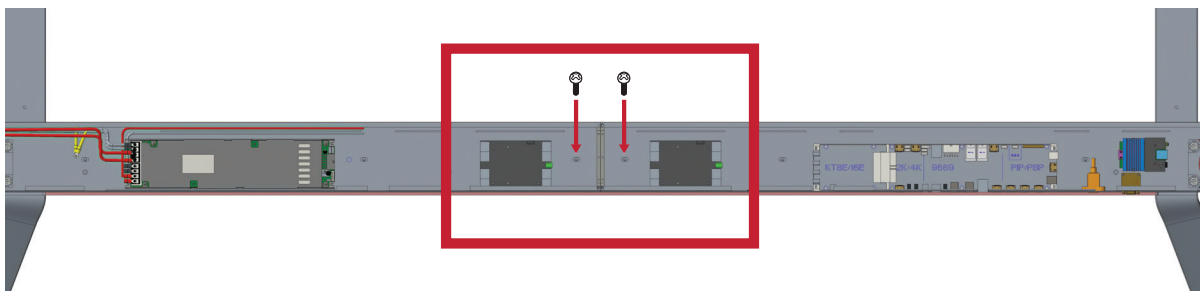

Installing the Middle Cabinets

1. Ensure the three (3) *Mounting Brackets* on the rear of the three (3) *Middle Cabinets* are positioned as shown below:

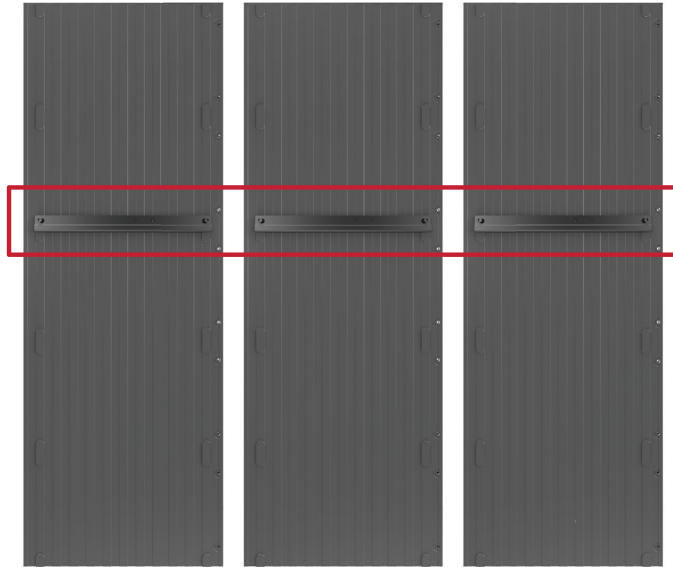

2. Carefully lift a *Cabinet* up onto the *Floor Stand*, securing the *Mounting Bracket* into the support channel of the *Top Cross Beam*. The bottom of the *Cabinet* will rest on the *Bottom Cross Beam*.

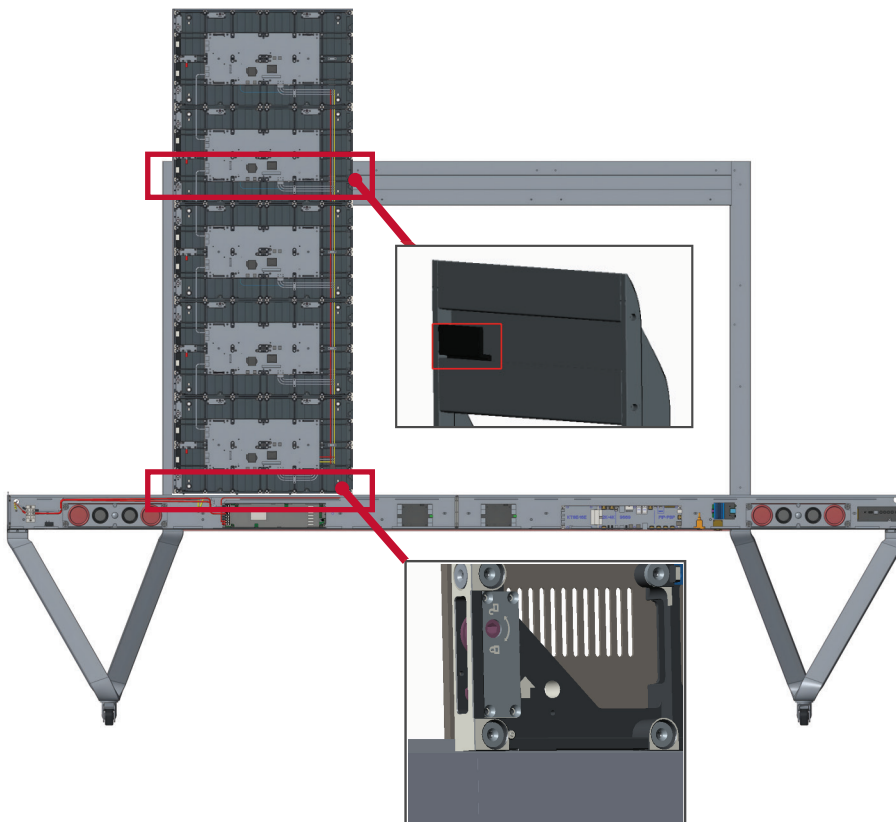

3. Secure the *Cabinet* to the *Support* with the provided screws (M6x10mm).

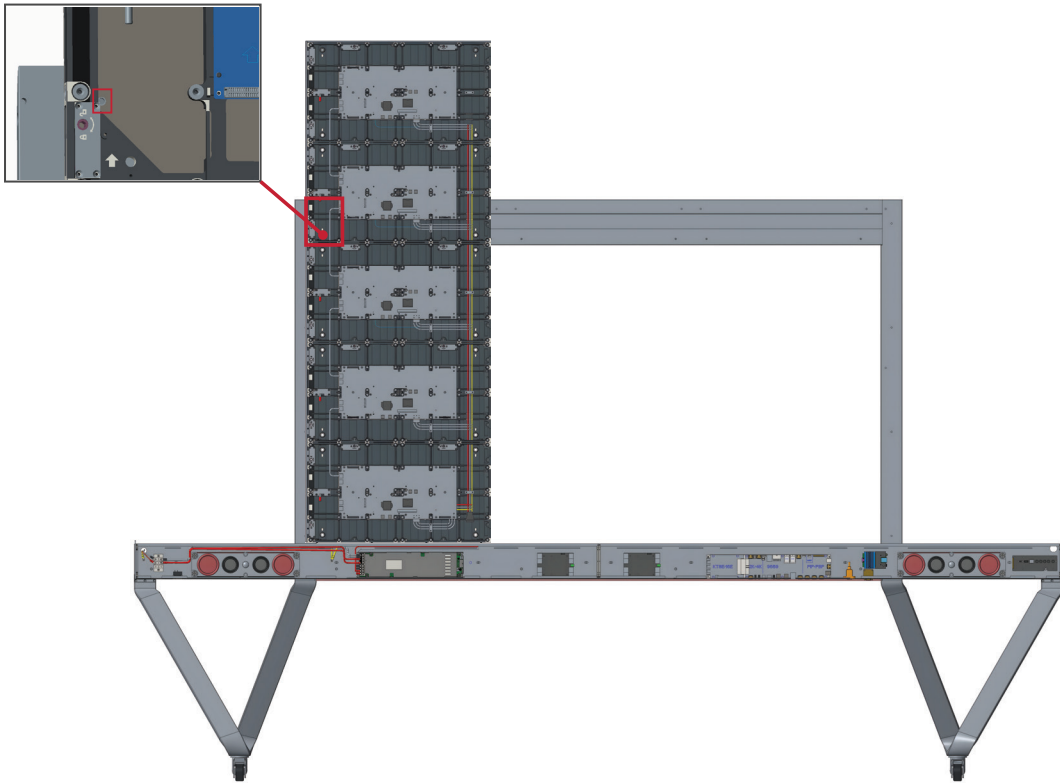

4. Push each *Locking Bolt* and lock each *Hook* with the hex tool to securely connect each cabinet together.

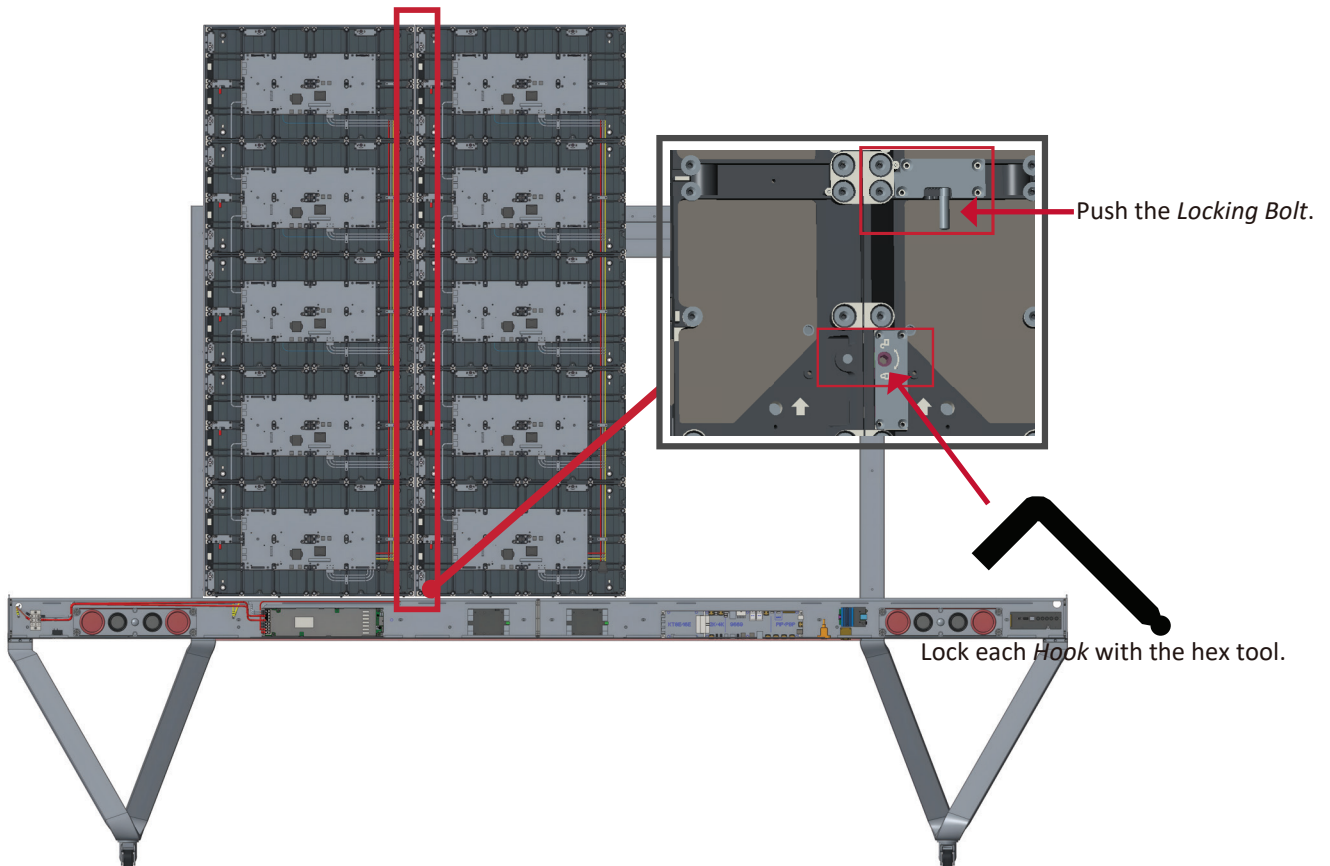

NOTE: There are five (5) *Locking Bolts* and 10 *Hooks* between each cabinet.

5. Repeat **Steps 2~4** for the remaining *Middle Cabinets*.

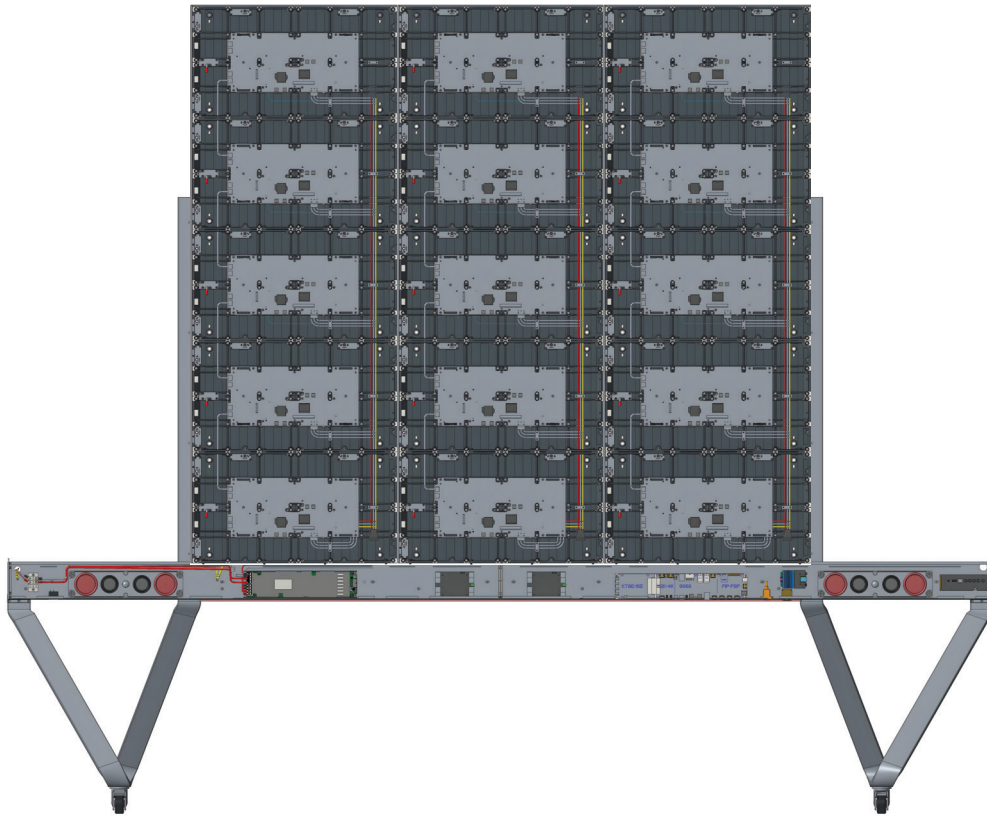

Installing the Left and Right Cabinet

1. Carefully lift the *Left and Right Cabinet* up onto the *Floor Stand*, securing the *Mounting Bracket* into the support channel of the *Top Cross Beam*. The bottom of the *Cabinet* will rest on the *Bottom Cross Beam*.

NOTE: Ensure the holes of the *Cabinet* and the *System Control Box* are aligned.

2. Push each *Locking Bolt* and lock each *Hook* with the hex tool to securely connect the *Left and Right Cabinet* to the *Middle Cabinets*.

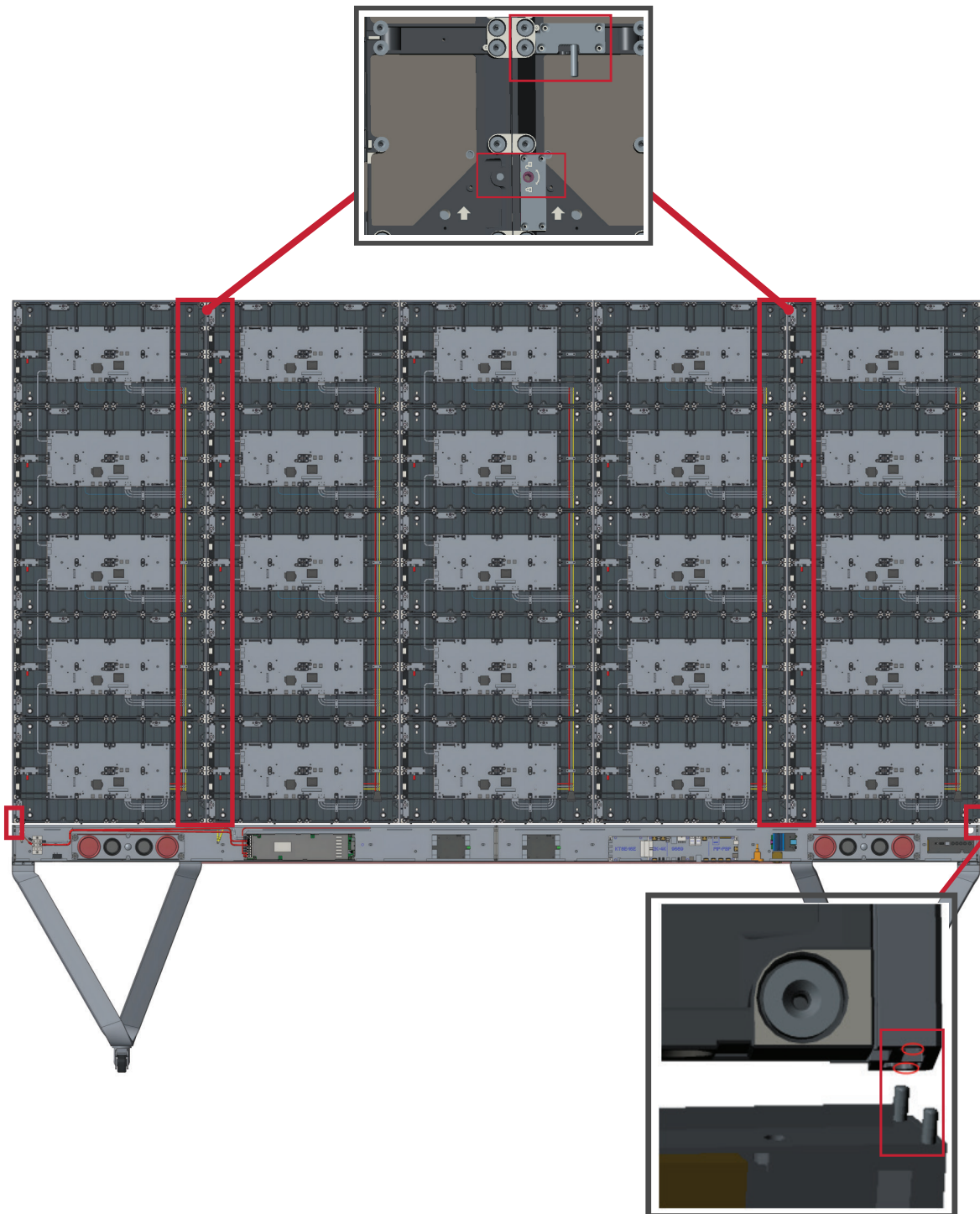

NOTE: There are five (5) *Locking Bolts* and 10 *Hooks* between each cabinet.

Connect the Network and Power Cables

Connect the Network and Power cables of each *Cabinet* to the *System Control Box*.

NOTE: There are five (5) Network and five (5) Power cables to connect.

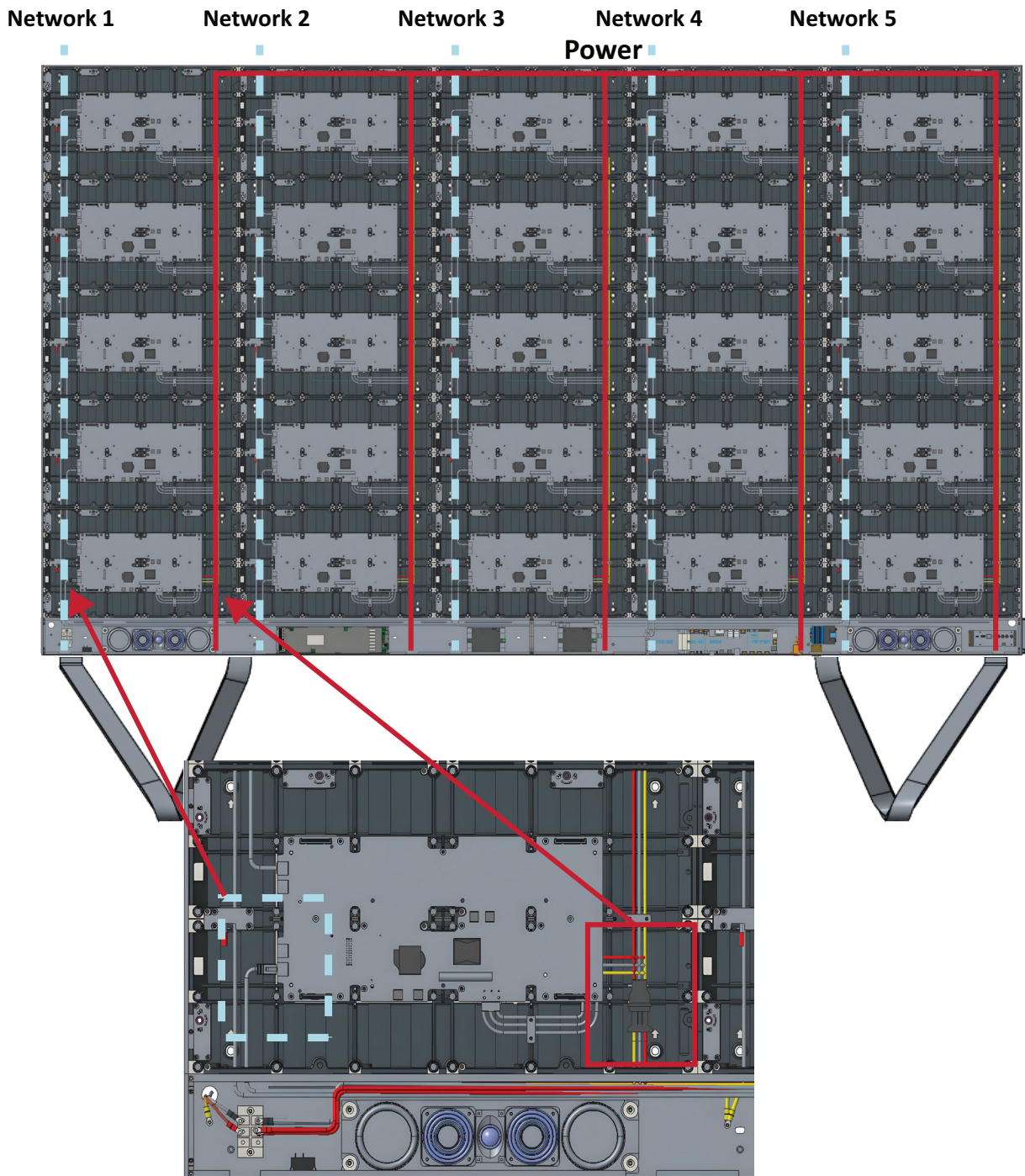

Installing the LED Modules

Install each *LED Module* onto the *Cabinets*, being sure to match the corresponding numbers on the *Module* to the *Cabinet*. Ensure each *Module* is flush and that there is little to no gap between each. It may be necessary to gently tap the *Module* to make it flush.

⚠ Please wear Anti-Static Gloves before handling the LED modules.



Installing System Control Box Covers

There are three (3) System Control Box Covers: Left, Middle, and Right.



1. Begin by installing the *Right Cover* onto the *System Control Box*.

NOTE: Ensure the **Power Button** cable is connected to the *System Control Box* Power cable before securing the *Cover*.

2. After connecting the **Power Button** cable, ensure the *Right Cover* is properly aligned with the *System Control Box*; then secure it with the 12 provided KM3x6mm screws.

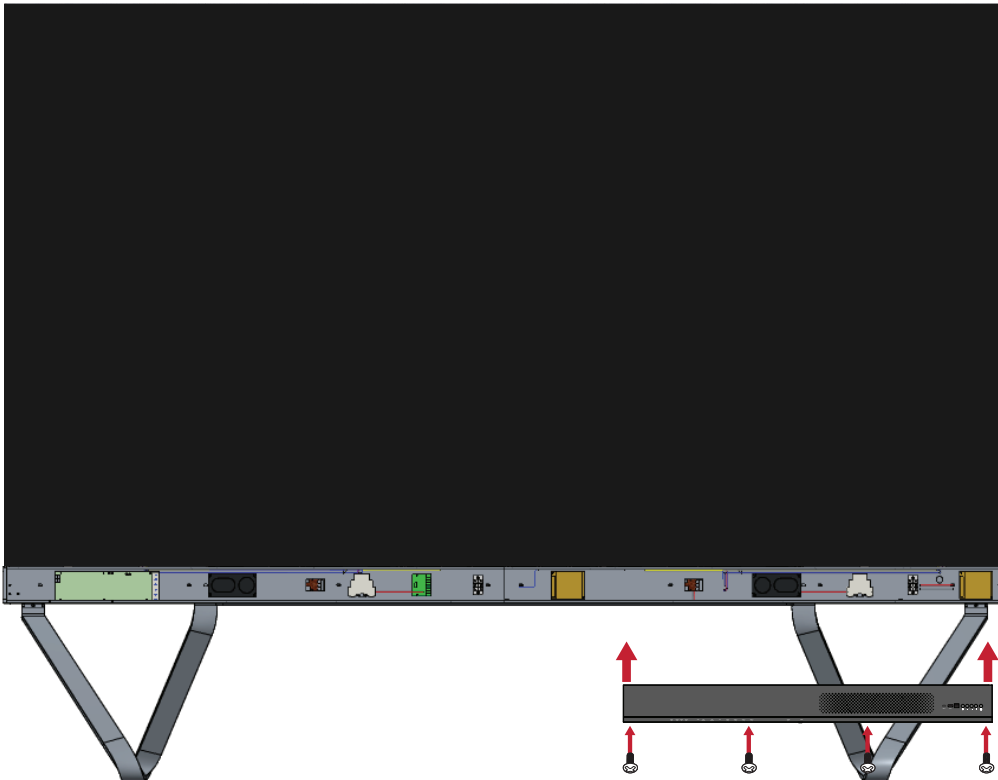

3. Repeat the above steps for the *Middle* and *Left Cover*. Once all of the *Covers* are secured, your LED Display is ready to use.



Detachable System Control Box

The *System Control Box* can be installed under the *Cabinets* (standard installation) for front access, or behind the *Cabinets*.

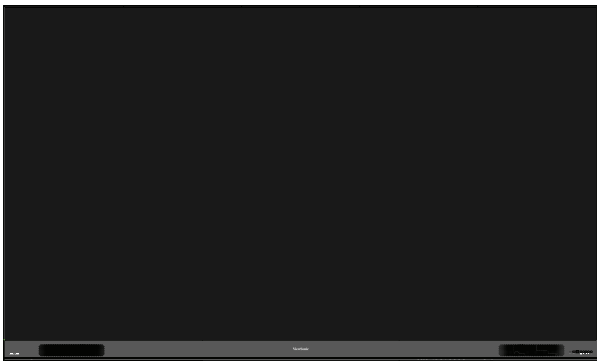

Standard Installation



Hidden System Control Box Installation

NOTE:

- [Standard Installation](#) video.
- Follow the below guide to install the display with the Hidden System Control Box layout.

Wall Mounting

Installing the Upper and Lower Wall Mount Brackets

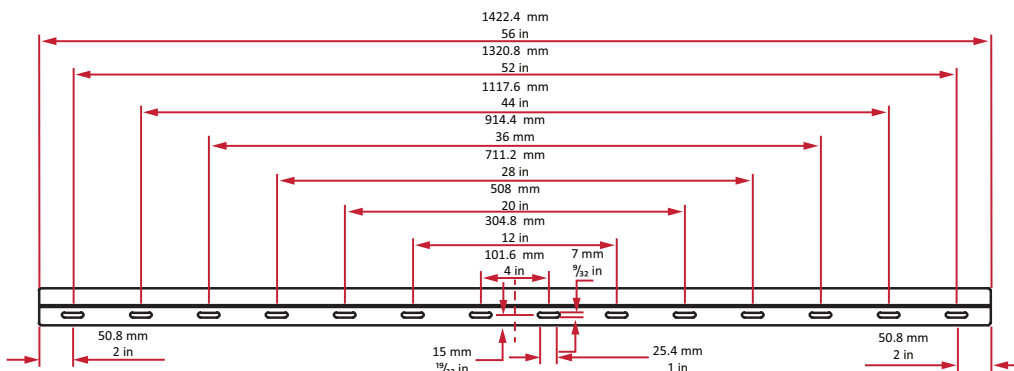

1. Ensure the wall area and size is an appropriate installation site.

NOTE: The height of the Upper *Wall Mount Brackets* must not be less than 90 ³⁵/₆₄" (2300 mm) from the ground.

2. Using the *Wall Mount Bracket* (pictured above) as a guide, mark at least eight (8) holes and pre-drill them.
3. Install the first Upper *Wall Mount Bracket* with the provided screws (M6x50mm Expansion for masonry; TA6x30mm for load bearing wood).

4. Repeat **Step 2**, ensuring the second *Upper Wall Mount Bracket* is level with the first upper bracket. Keep a 3 $\frac{11}{32}$ " (85 mm) space between the two brackets.

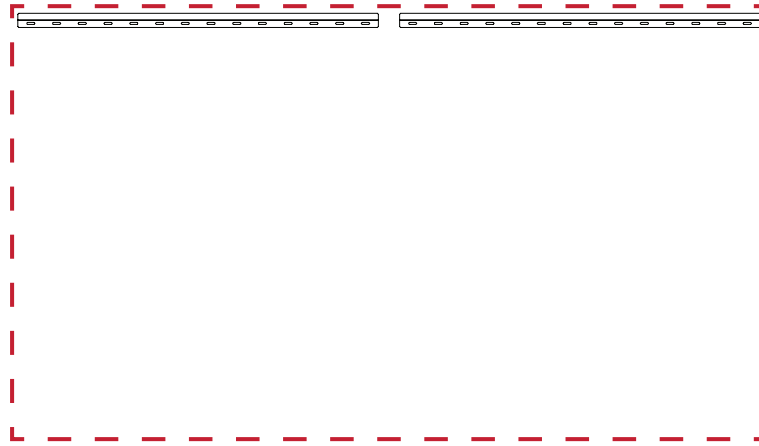

5. Install the *Lower Wall Mount Brackets* in the same manner as the *Upper Wall Mount Brackets*. The distance between the *Upper* and *Lower Wall Mount Brackets* is 53 $\frac{5}{32}$ " (1350 mm).

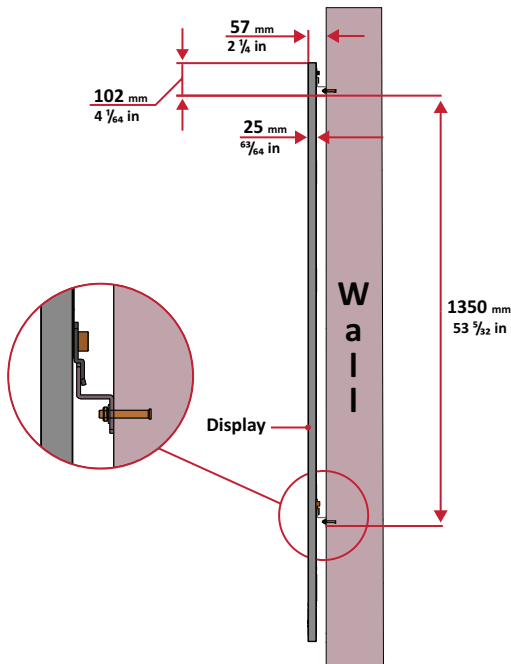

NOTE: You can also install the *Upper Wall Mount Brackets*, hang the screen, and then install the *Lower Wall Mount Brackets* for a more precise fit.

- ❗ Ensure the wall can safely support 297.62 lbs. (135 kg).
- ❗ Ensure the deviation of the wall surface is $< \frac{13}{64}$ " (< 5 mm).

6. After installing both Upper and Lower *Wall Mount Brackets*, the installation wall should look like:

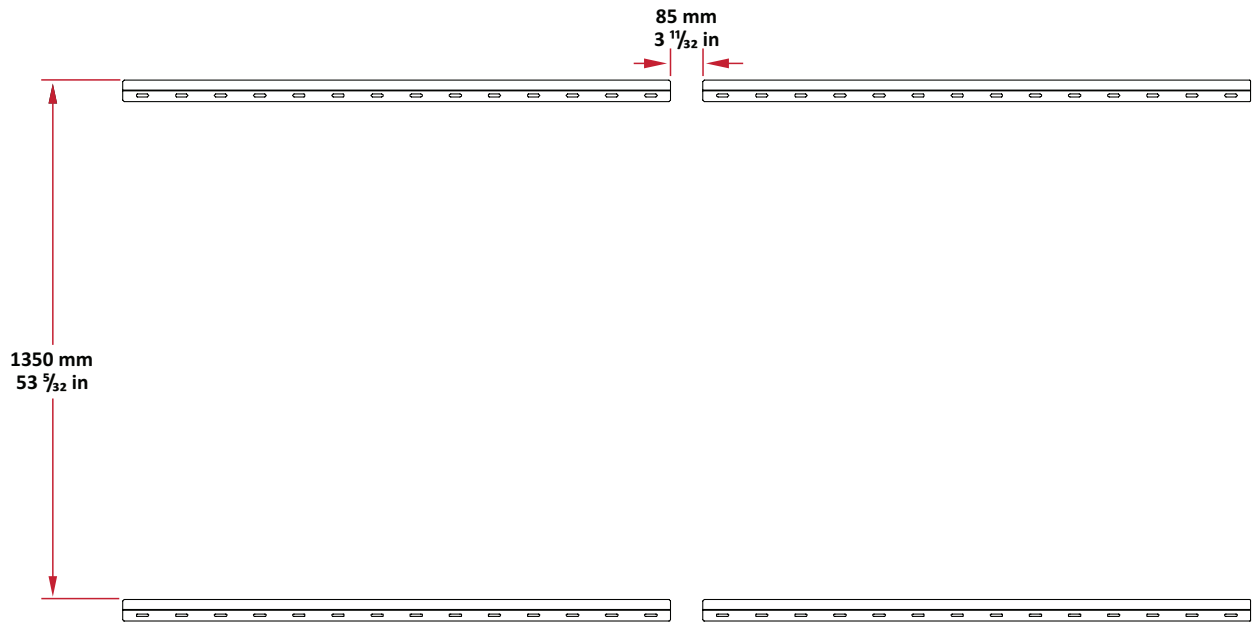

Installing the Cabinets

1. Ensure the *Mounting Brackets* on the rear of the five (5) Middle Cabinets are positioned at the top and bottom mounting positions as shown below:

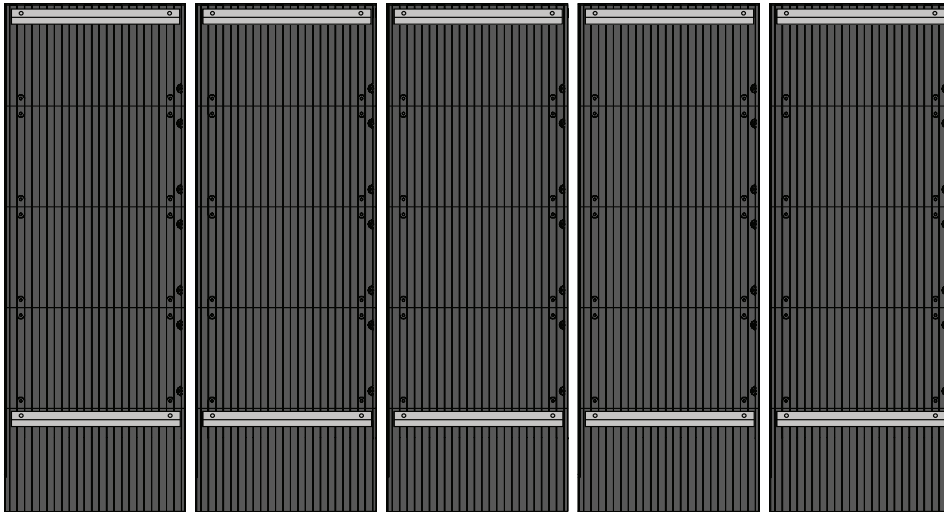

2. Carefully lift each *Cabinet* up onto the *Upper Wall Mount Brackets*, starting from the left.

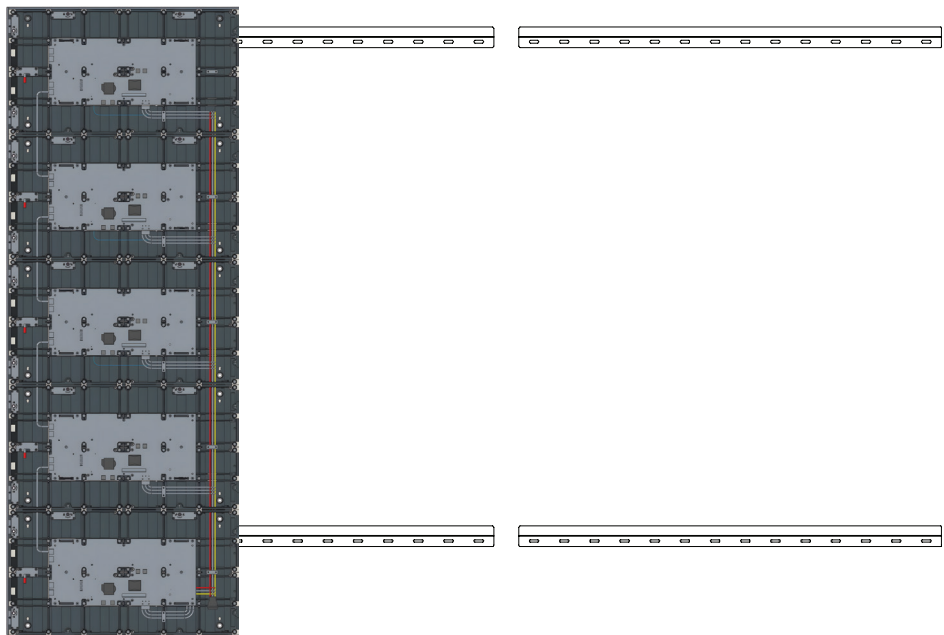

3. Ensure the *Mounting Brackets* sit securely on the *Wall Mount Brackets* as shown below.

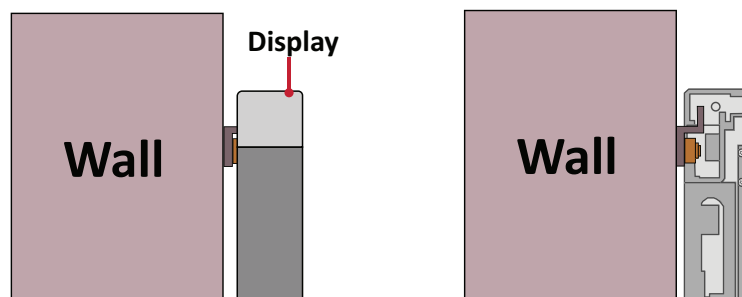

4. Push each *Locking Bolt* and lock each *Hook* with the hex tool to securely connect each cabinet together. It may be necessary to align the hole with an Allen wrench in order to engage the *Locking Bolt*.

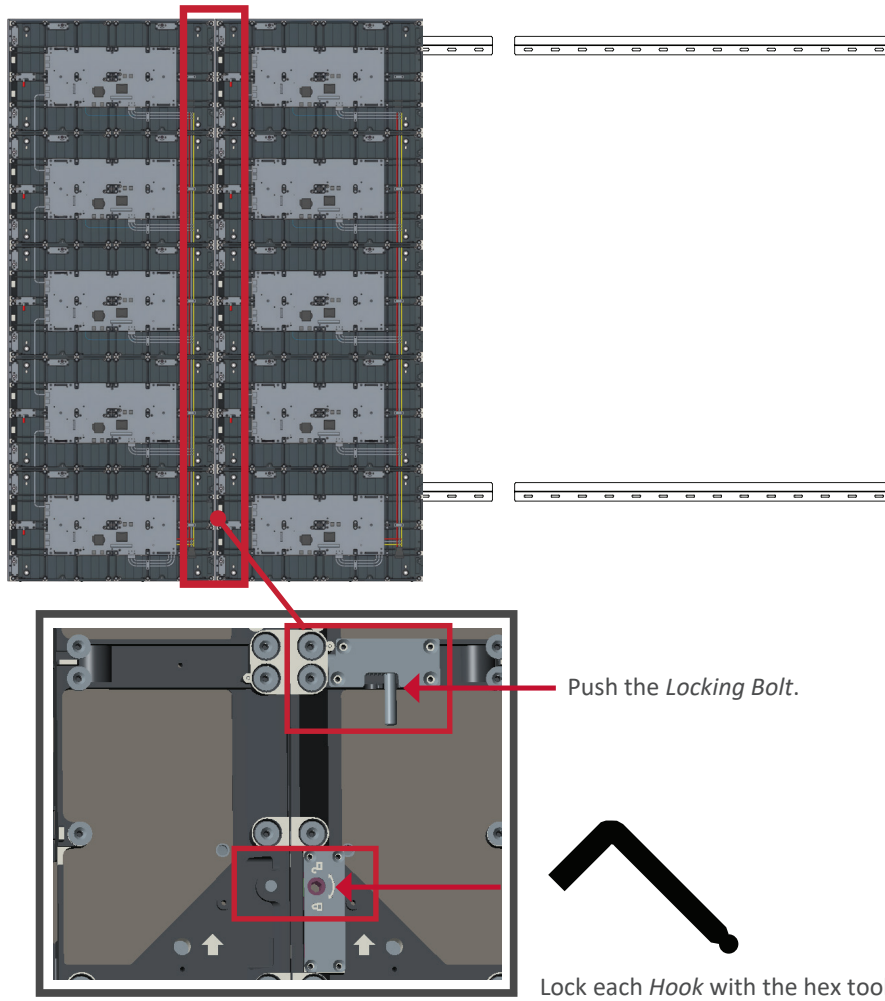

NOTE: There are five (5) *Locking Bolts* and 10 *Hooks* between each cabinet.

5. Place the remaining *Cabinets* up onto the *Upper Wall Mount Brackets*. Install from left to right, ensuring the *Mounting Brackets* sit securely on the *Wall Mount Brackets*.
6. Repeat **Step 4**, securing the cabinets together with each *Locking Bolt* and *Hook*.

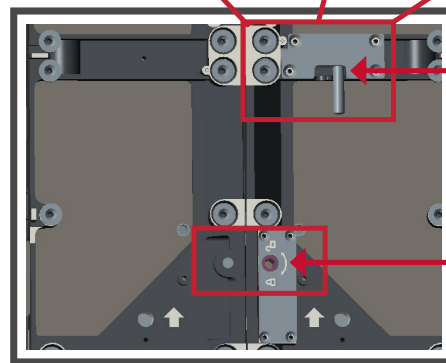
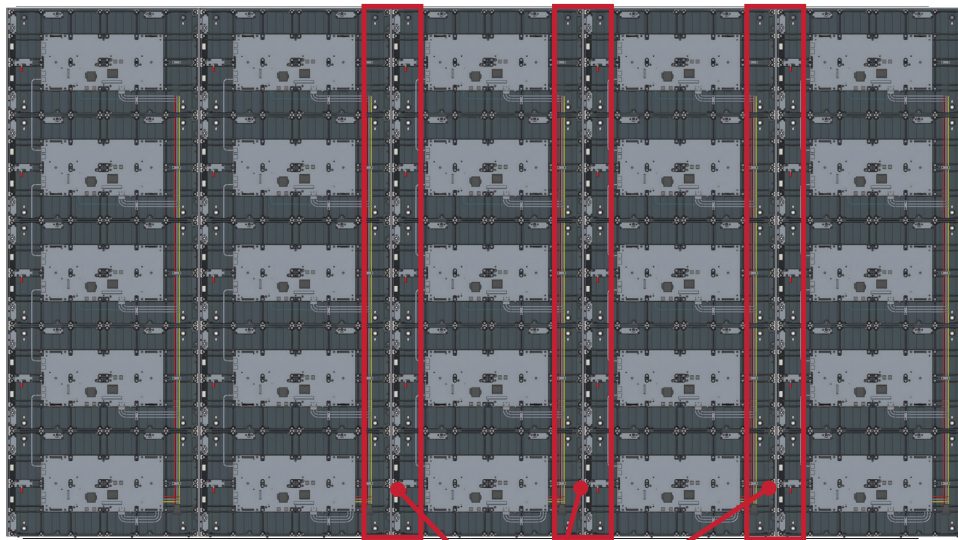

Push the *Locking Bolt*.



Lock each *Hook* with the hex tool.

NOTE: There are five (5) *Locking Bolts* and 10 *Hooks* between each cabinet.

Connecting the System Control Box (Hidden Installation)

1. Carefully unfold the *System Control Box* panel. Ensure the main system control board is on the right.

NOTE: Use caution as the *System Control Box* panel is separated into two pieces with wires attached.

2. Install the left part of *System Control Box* using the M6x16mm screws behind the *Cabinet*.

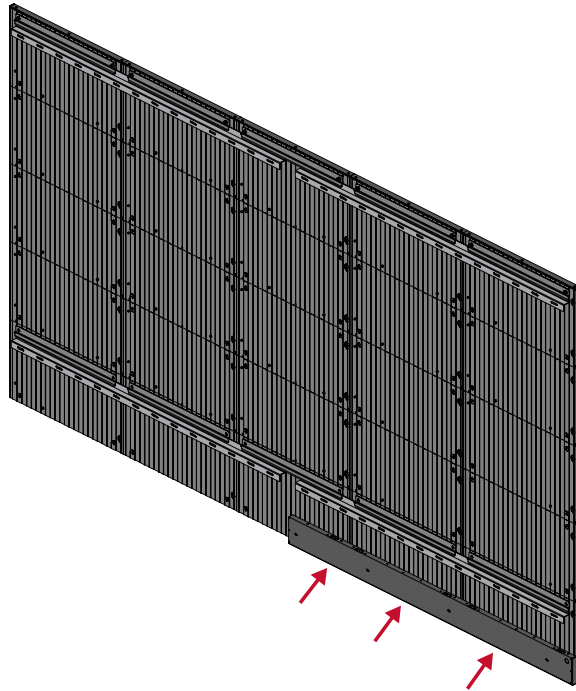

3. Install the right part of the *System Control Box* using the M6x16mm screws behind the *Cabinet*.

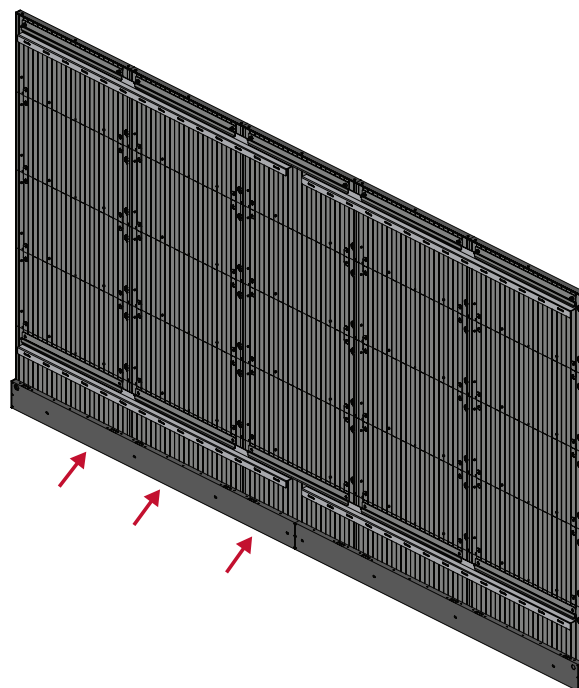

4. Connect the Network and Power cables of the *Cabinets* to the *System Control Box*.

NOTE: There are five (5) Network and five (5) Power cables to connect.

- Route the Power cable through the opening provided in the *Cabinet* and connect it to the power plug.

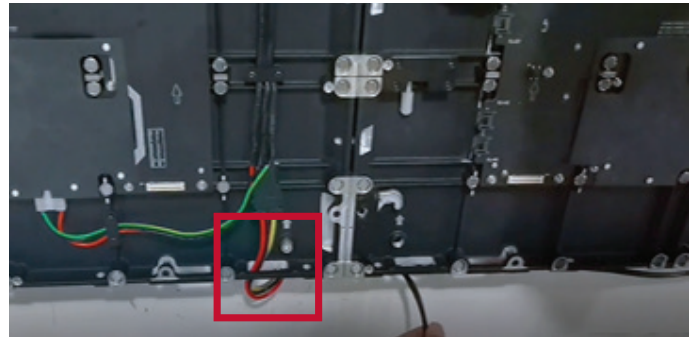
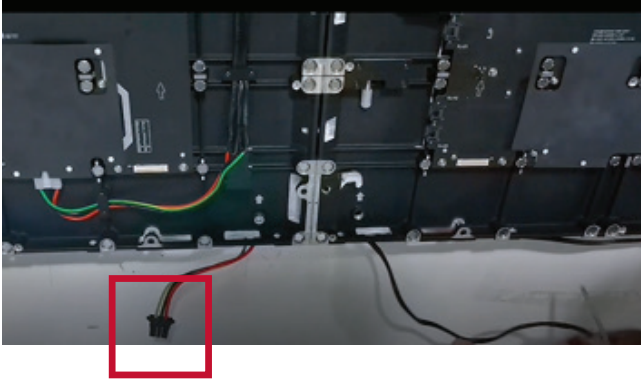

- Route the Network cable through the opening provided in the *Cabinet* into an "S-shape" and connect it to the network port.

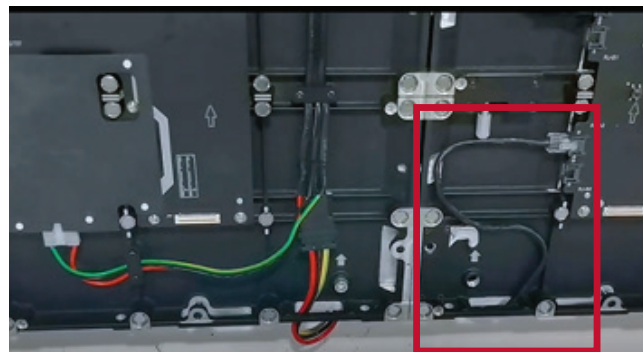

5. Install the bezels from the bottom of the screen and use the M6x10mm screws to secure it to the *Cabinet*.

Installing the LED Modules

1. Install each *LED Module* onto the *Cabinets*, being sure to match the corresponding numbers on the *Module* to the *Cabinet*.

! Please wear Anti-Static Gloves before handling the LED modules.

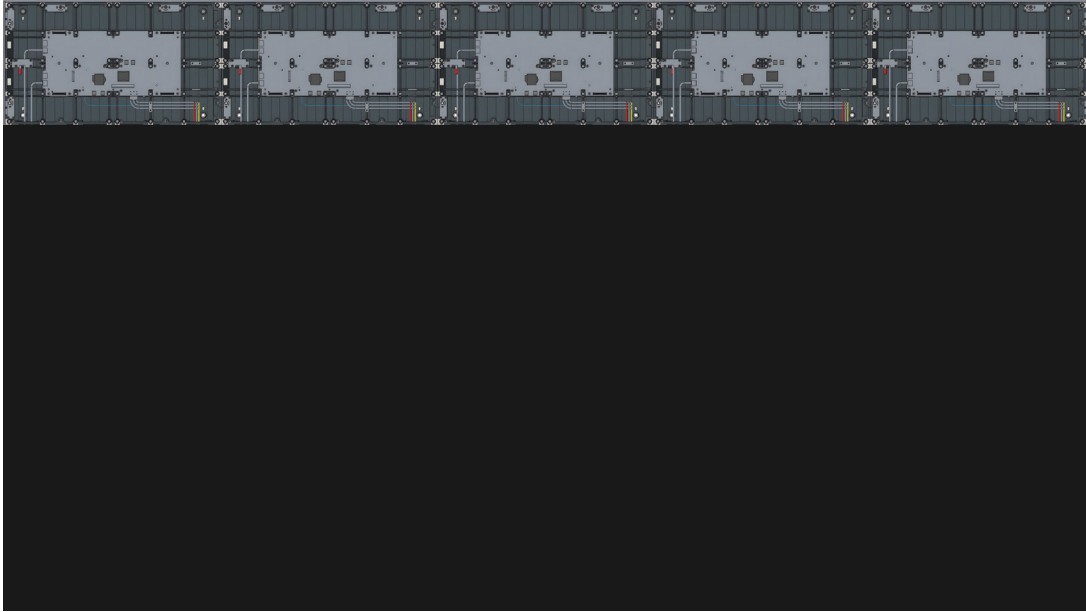

2. Ensure each *Module* is flush and that there is little to no gap between each. It may be necessary to gently tap the module to make it flush.



Dual-Screen Splicing

Two (2) DirectView LED Displays can be installed together to create one (1) large display.

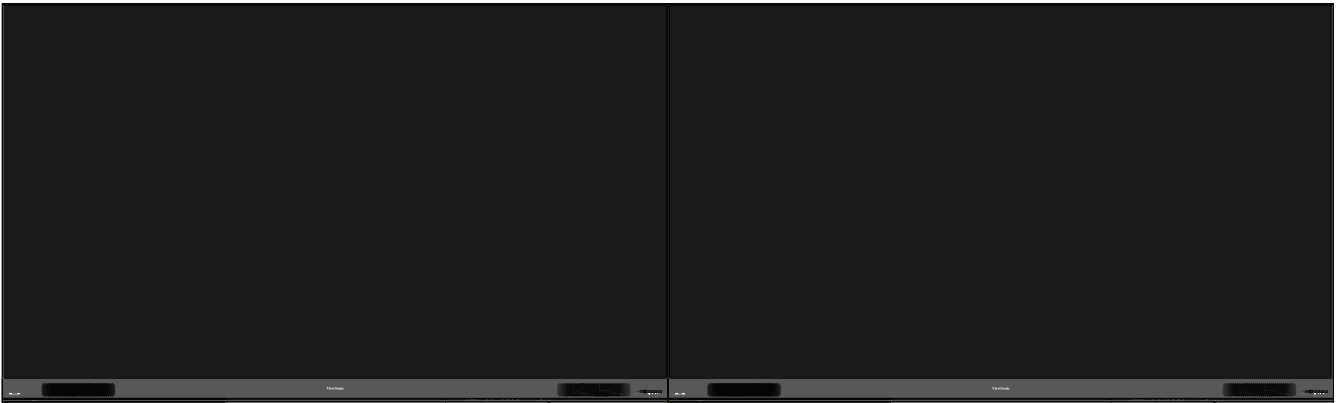

Standard Installation

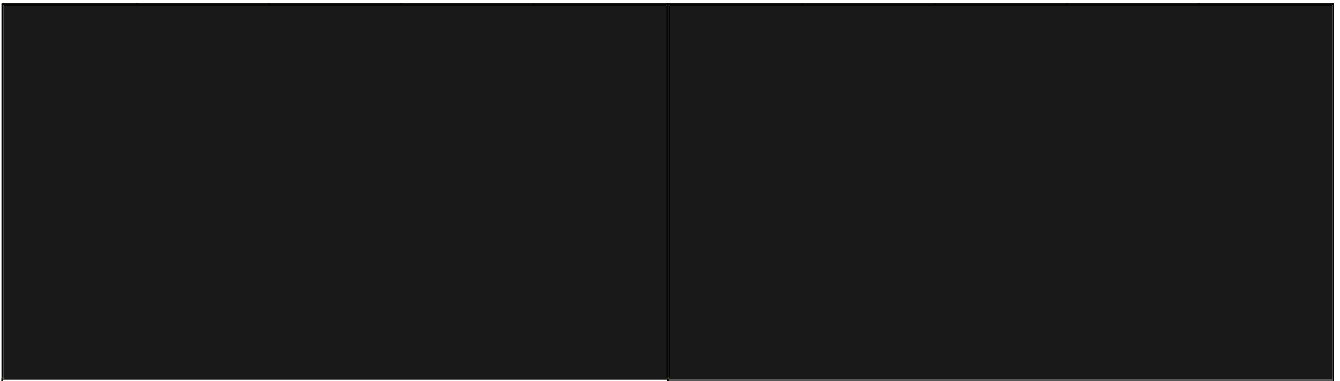

Hidden System Control Box Installation

NOTE: The *System Control Boxes* can be installed under the *Cabinets* (standard installation) for front access, or behind the *Cabinets*.

Wall Mounting

Installing the Upper and Lower Wall Mount Brackets

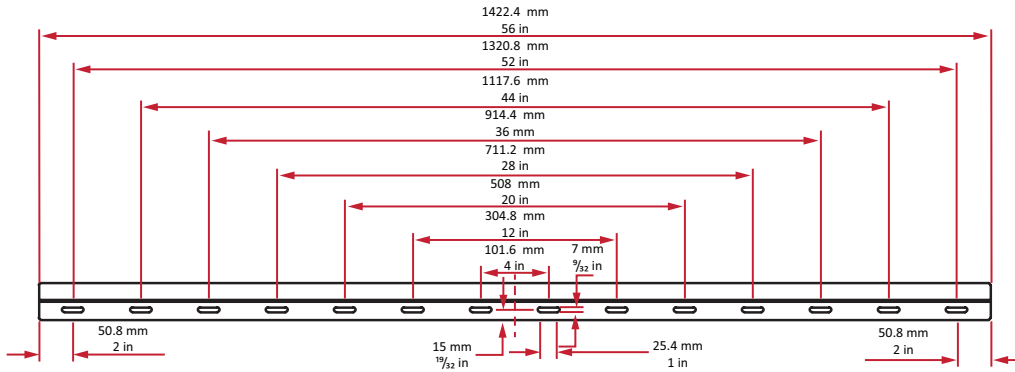

1. Ensure the wall area and size is an appropriate installation site.
NOTE: The height of the Upper *Wall Mount Brackets* must not be less than 90 ³⁵/₆₄" (2300 mm) from the ground.
2. Using the *Wall Mount Bracket* (pictured above) as a guide, mark at least eight (8) holes and pre-drill them.
3. Install the first Upper *Wall Mount Bracket* with the provided screws (M6x50mm Expansion for masonry; TA6x30mm for load bearing wood).
4. Repeat **Step 2**, ensuring the second Upper *Wall Mount Bracket* is level with the first upper bracket. Keep a 3 1/4" (82.6 mm) space between the two brackets.

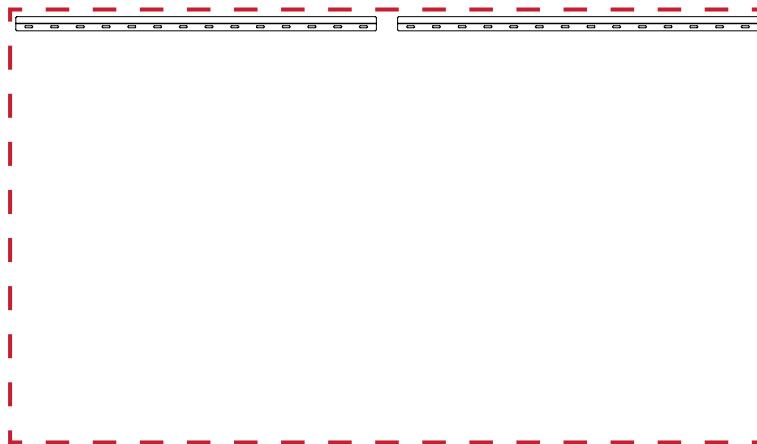

5. Install the Lower *Wall Mount Brackets* in the same manner as the Upper *Wall Mount Brackets*. The distance between the Upper and Lower *Wall Mount Brackets* is 53 ⁵/₃₂" (1350 mm).

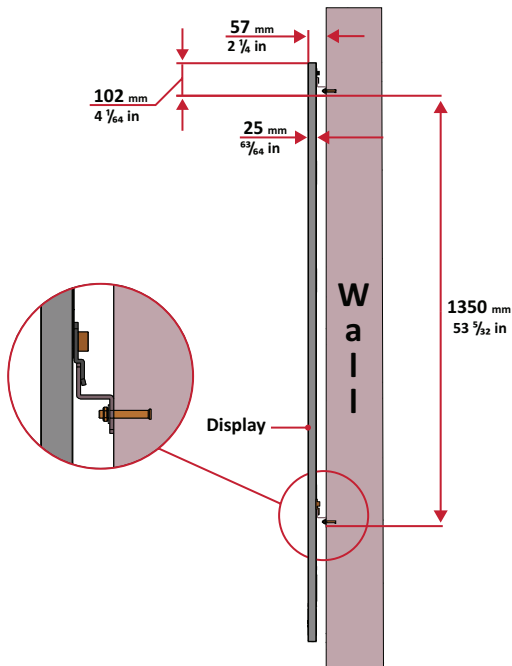

NOTE: You can also install the Upper Wall Mount Brackets, hang the screen, and then install the Lower Wall Mount Brackets for a more precise fit.

- ❗ Ensure the wall can safely support 297.62 lbs. (135 kg).
- ❗ Ensure the deviation of the wall surface is < ¹³/₆₄" (< 5 mm).

6. Repeat **Steps 1~5** for the second display. Keep a 2 ⁵⁵/₆₄" (72.8 mm) space between the first and second display's *Wall Mount Brackets*.

7. After installing both Upper and Lower *Wall Mount Brackets* of both displays, the installation wall should look like:

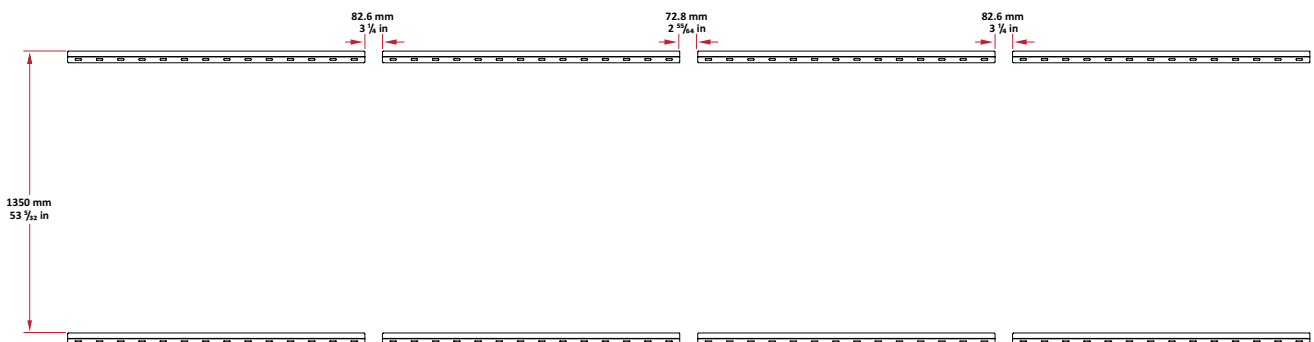

Installing the Cabinets

1. Ensure the *Mounting Brackets* on the rear of the five (5) Middle Cabinets are positioned at the top and bottom mounting positions as shown below:

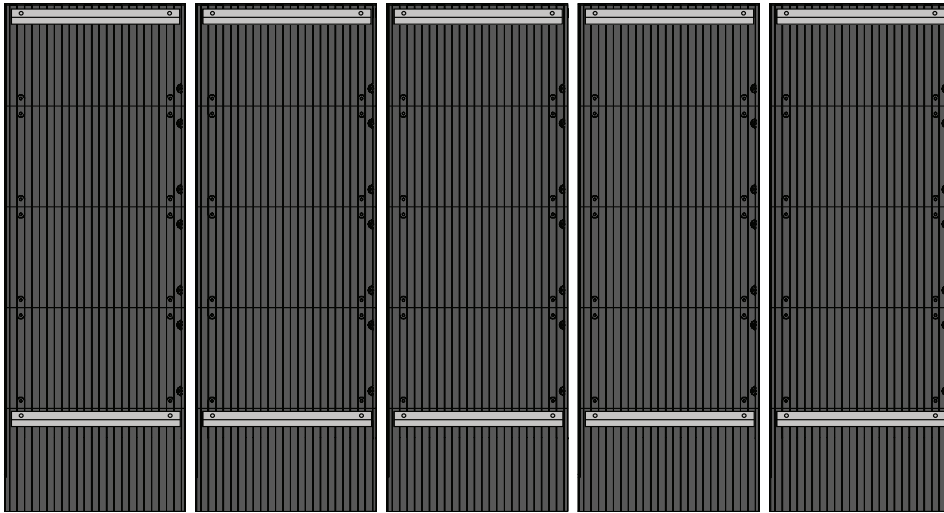

2. Carefully lift each *Cabinet* up onto the *Upper Wall Mount Brackets*, starting from the left.

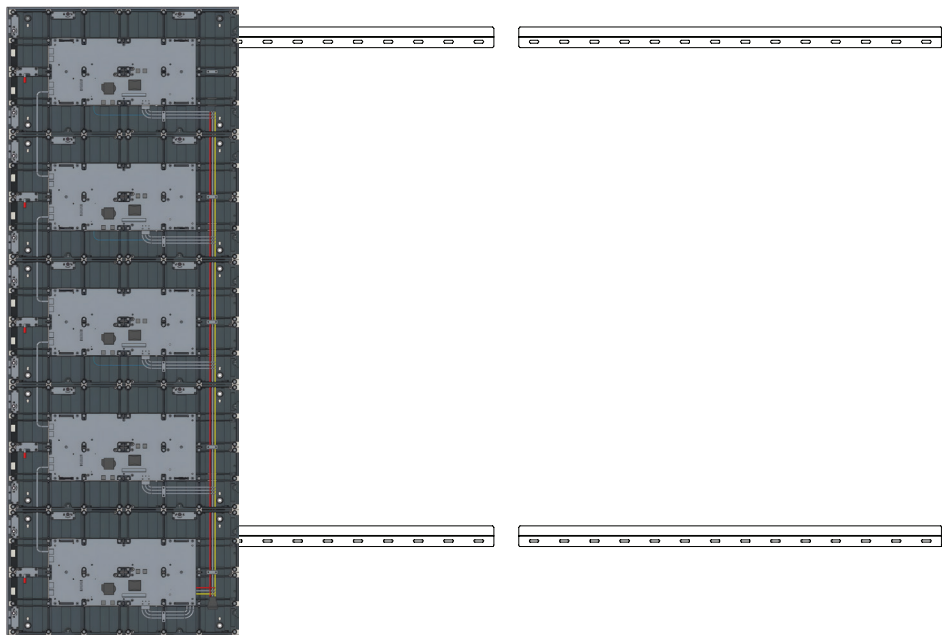

3. Ensure the *Mounting Brackets* sit securely on the *Wall Mount Brackets* as shown below.

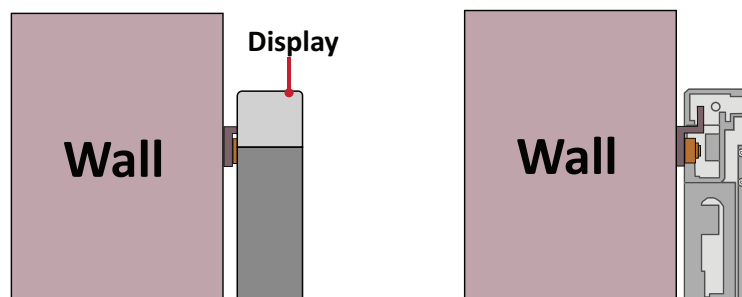

4. Push each *Locking Bolt* and lock each *Hook* with the hex tool to securely connect each cabinet together. It may be necessary to align the hole with an Allen wrench in order to engage the *Locking Bolt*.

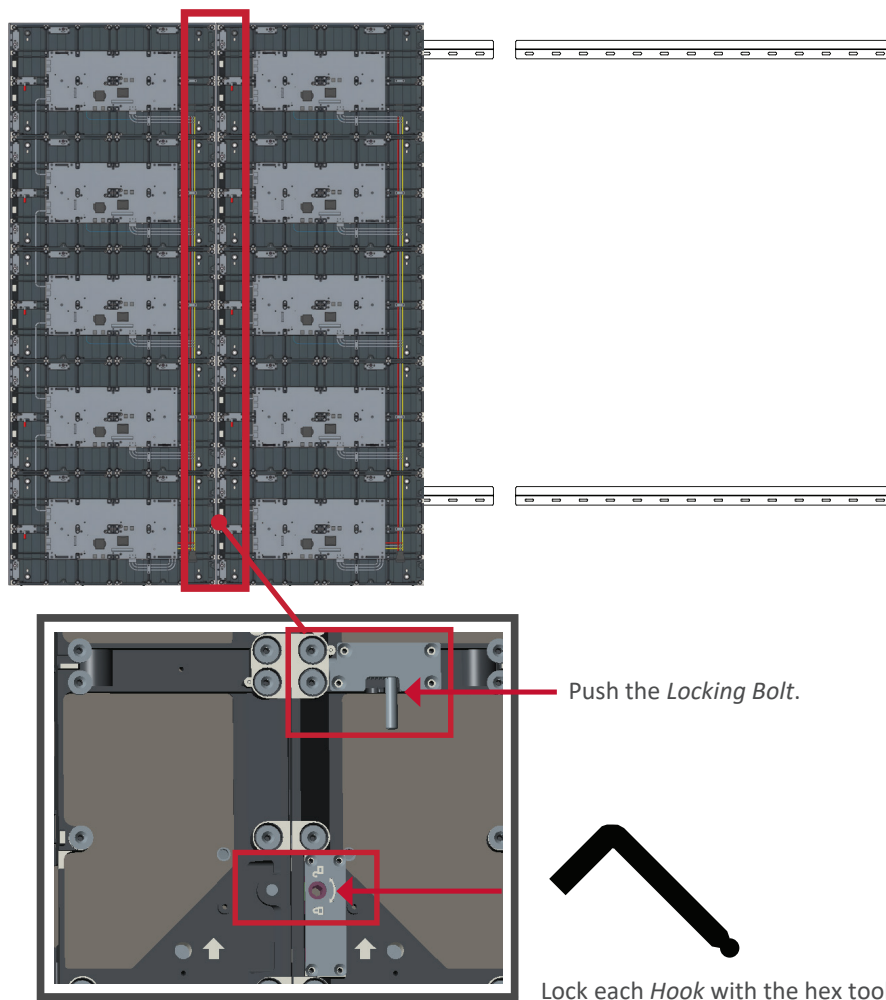

NOTE: There are five (5) *Locking Bolts* and 10 *Hooks* between each cabinet.

5. Place the remaining *Cabinets* up onto the *Upper Wall Mount Brackets*. Install from left to right, ensuring the *Mounting Brackets* sit securely on the *Wall Mount Brackets*.
6. Repeat **Step 4**, securing the cabinets together with each *Locking Bolt* and *Hook*.

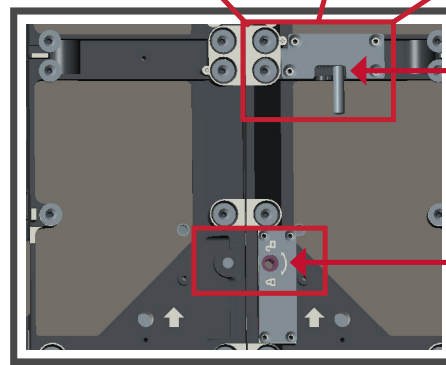
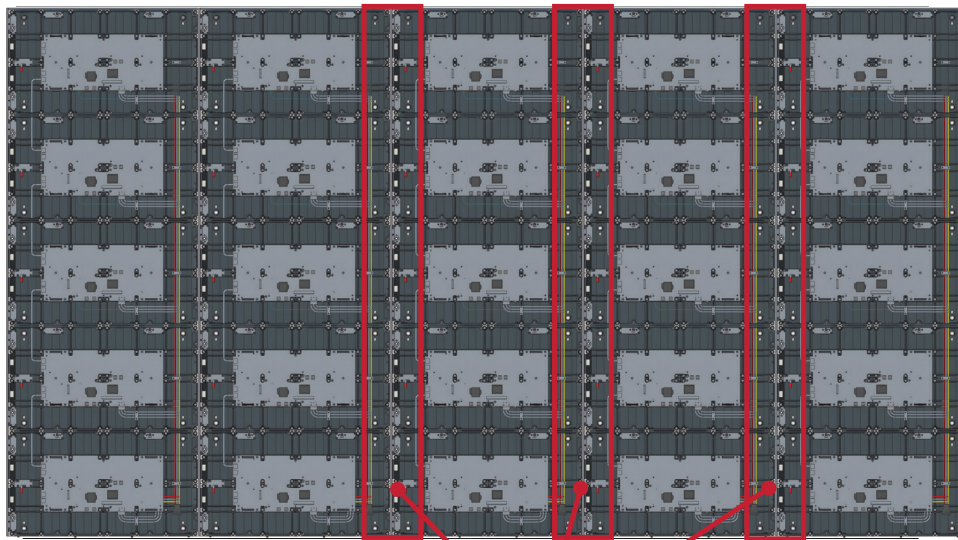

Push the *Locking Bolt*.

Lock each *Hook* with the hex tool.

NOTE: There are five (5) *Locking Bolts* and 10 *Hooks* between each cabinet.

7. Repeat **Steps 1~6** for the second display.
8. After installing the *Cabinets* of both displays, the installation wall should look like:

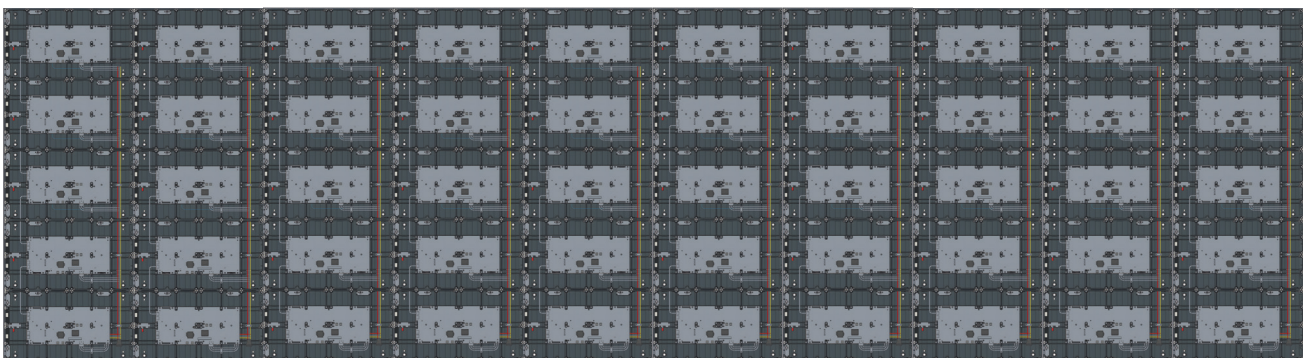

Connecting the System Control Box (Standard Installation)

1. Carefully unfold the *System Control Box* panel. Ensure the main system control board is on the right.

NOTE: Use caution as the *System Control Box* panel is separated into two pieces with wires attached.

2. Starting from the left side, align the holes of the *Cabinet* with the *System Control Box* to attach.

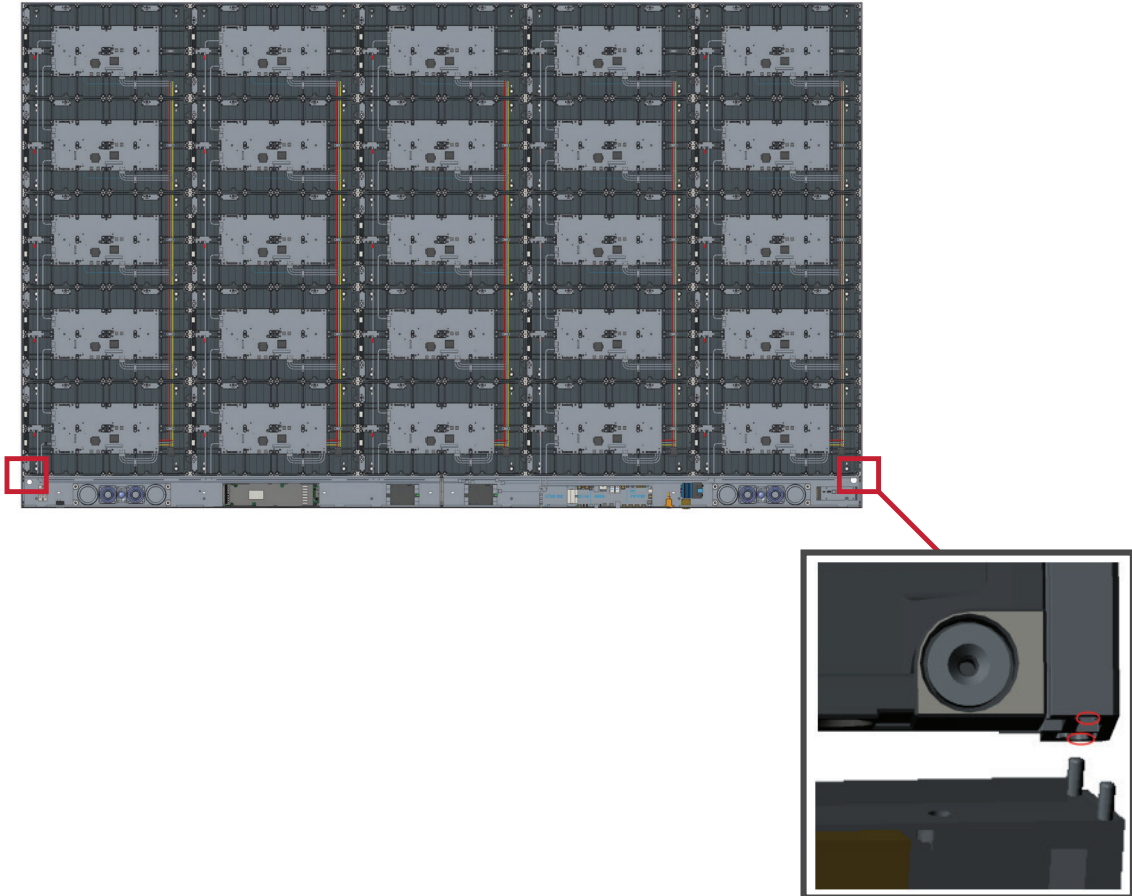

3. You can also reroute the power cable for cable management. Loosen the two (2) PWM 4x6mm screws, pull the power cable out, thread the power cable through the hole and then fasten the screws tightly.

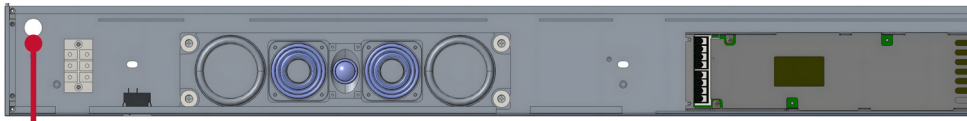

Hole for cable management

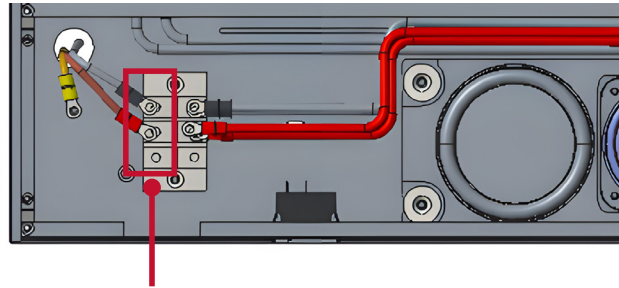

Two (2) PWM 4x6mm Screws

! Professional installation only.

4. Further secure the *System Control Box* to the *Cabinets* with the 20 provided M6x10mm screws.

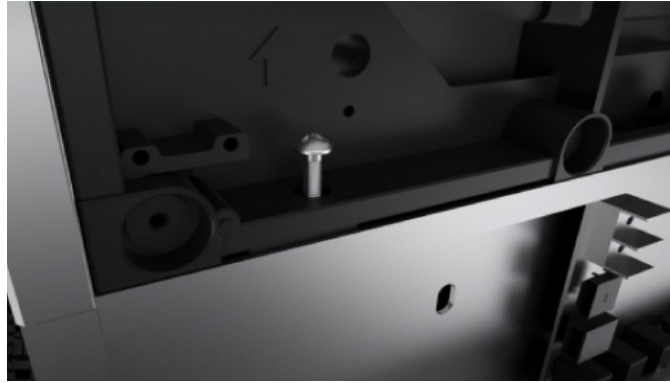

5. Connect the Network and Power cables of the *Cabinets* to the *System Control Box*.

NOTE: There are five (5) Network and five (5) Power cables to connect.

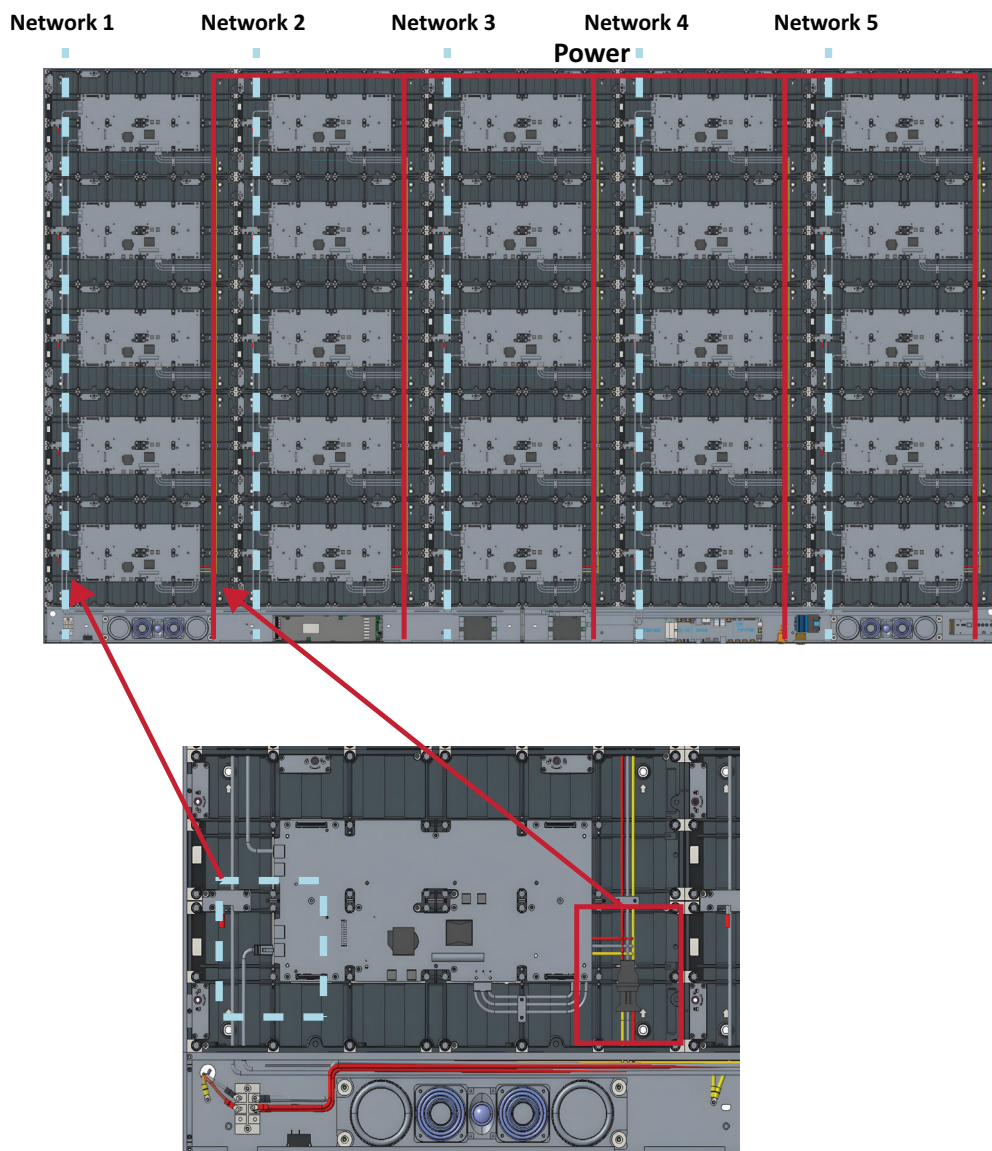

6. Repeat **Steps 1~5** for the second display.

7. After installing the *System Control Box* of both displays, the installation wall should look like:

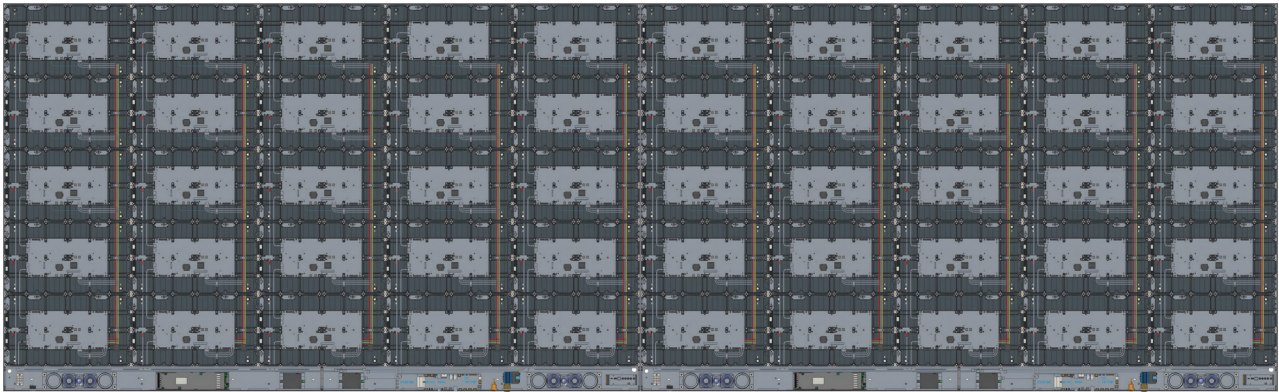

Display 1

Display 2

8. Connect one end of an HDMI cable to the **HDMI OUT** port of Display 2. Then, connect the other end of the cable to the **HDMI IN** port of Display 1.

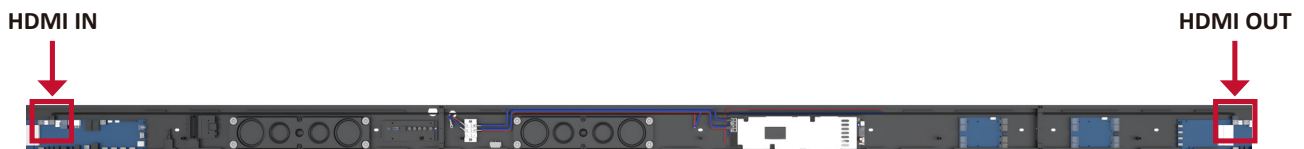

NOTE: Route the HDMI cable as shown below:

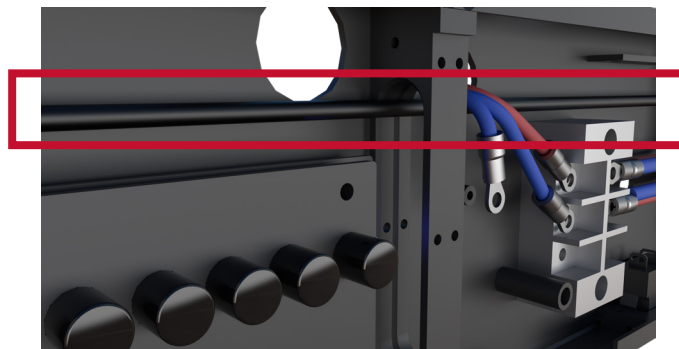

9. Install the *System Control Box Covers* with the KM3x6mm screws from left to right (i.e., Display 1 left cover, Display 1 middle cover, Display 1 right cover, Display 2 left cover, etc.).

NOTE: Refer to page 26 for more information.

Connecting the System Control Box (Hidden Installation)

1. Connect one end of an HDMI cable to the **HDMI OUT** port of Display 2. Then, connect the other end of the cable to the **HDMI IN** port of Display 1.

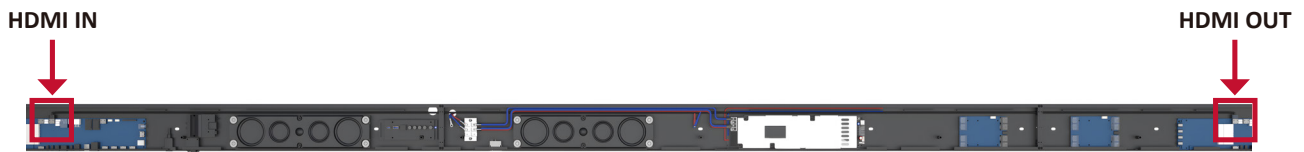

NOTE: Route the HDMI cable as shown below:

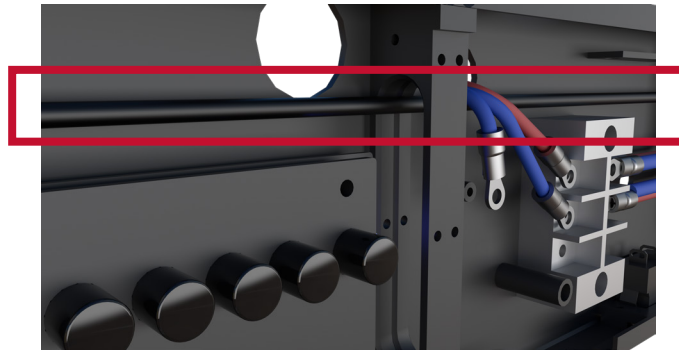

2. Carefully unfold the *System Control Box* panel. Ensure the main system control board is on the right.

NOTE: Use caution as the *System Control Box* panel is separated into two pieces with wires attached.

3. Install the left part of *System Control Box* using the M6x16mm screws behind the *Cabinet*.

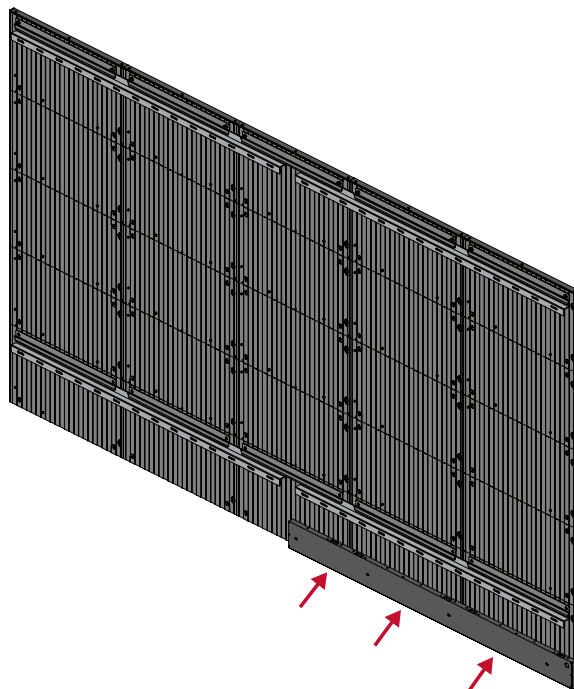

4. Install the right part of the *System Control Box* using the M6x16mm screws behind the *Cabinet*.

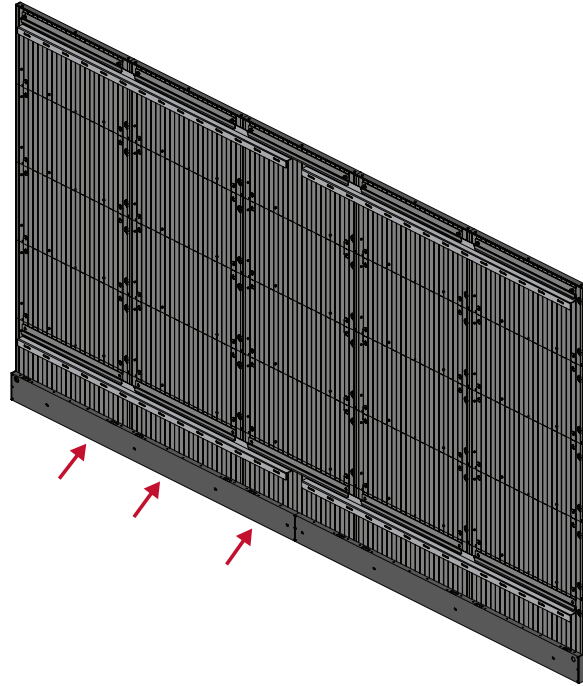

5. Connect the Network and Power cables of the *Cabinets* to the *System Control Box*.

NOTE: There are five (5) Network and five (5) Power cables to connect.

- Route the Power cable through the opening provided in the *Cabinet* and connect it to the power plug.

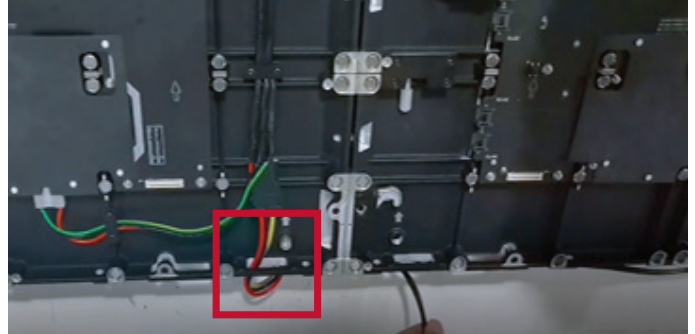
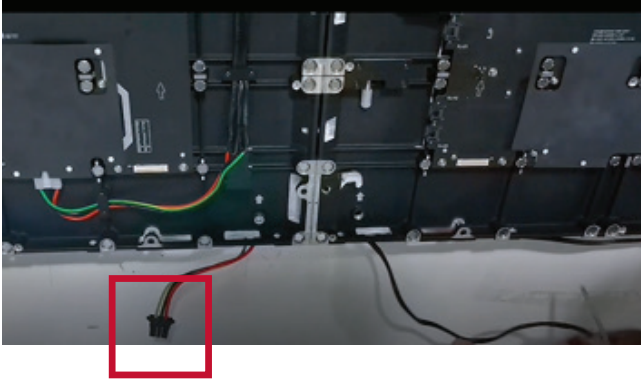

- Route the Network cable through the opening provided in the *Cabinet* into an "S-shape" and connect it to the network port.

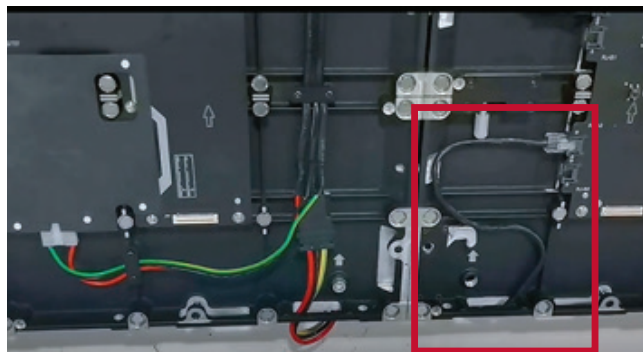

6. Repeat **Steps 1~4** for the second display.

7. Install the bezels from the bottom of the screen and use the M6x10mm screws to secure it to the *Cabinet*.

Installing the LED Modules

1. Starting with Display 1, install each *LED Module* onto the *Cabinets*, being sure to match the corresponding numbers on the *Module* to the *Cabinet*.

! Please wear Anti-Static Gloves before handling the LED modules.

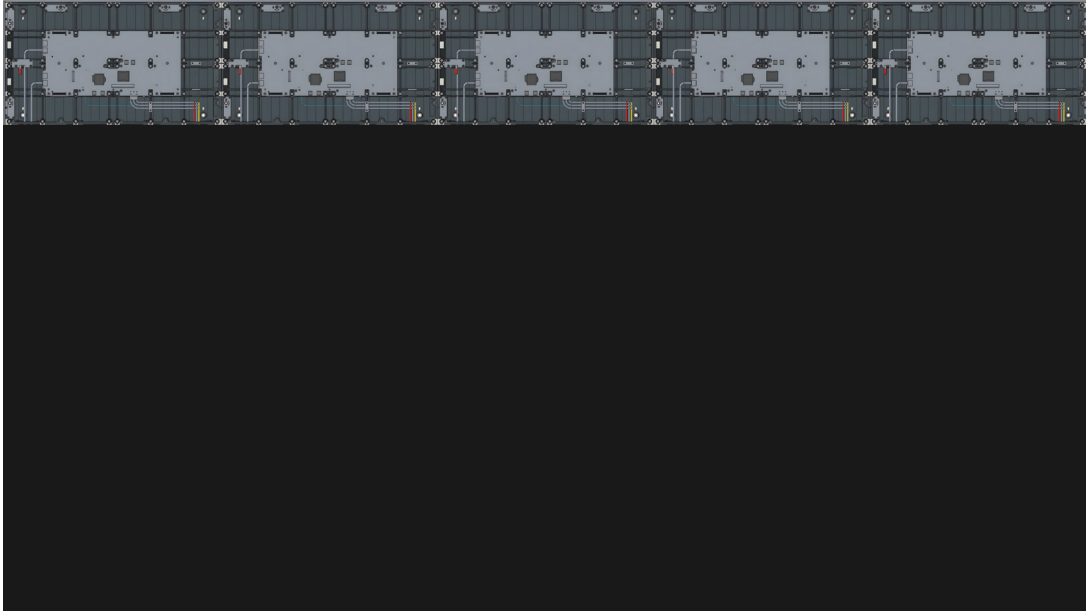

2. Ensure each *Module* is flush and that there is little to no gap between each. It may be necessary to gently tap the module to make it flush.



3. Once Display 1 is complete, repeat **Steps 1~2** for Display 2.

4. After installing the *LED Modules* of both displays, the installation wall should look like:



Standard Installation

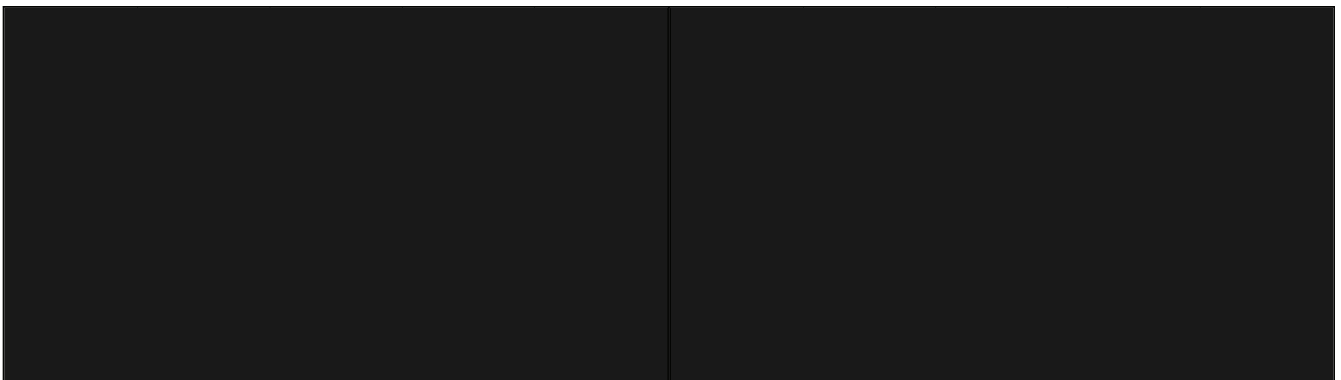

Hidden System Control Box Installation

Portrait Mode

The DirectView LED Display can be installed in either Landscape or Portrait orientation.

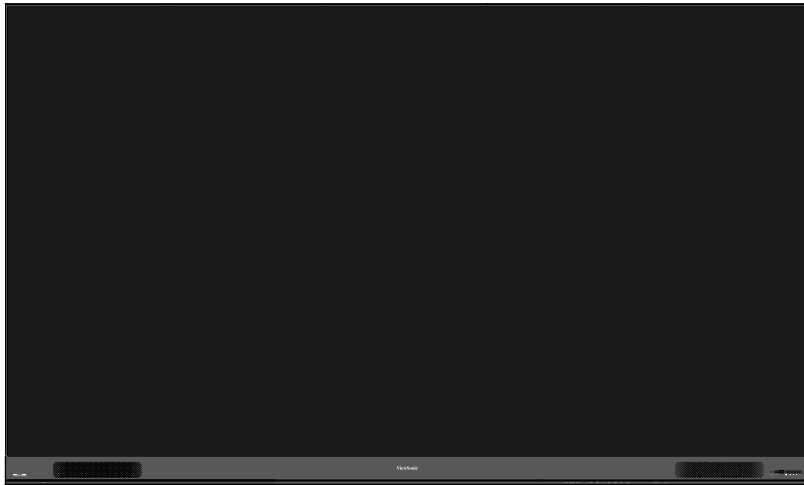

Landscape Installation

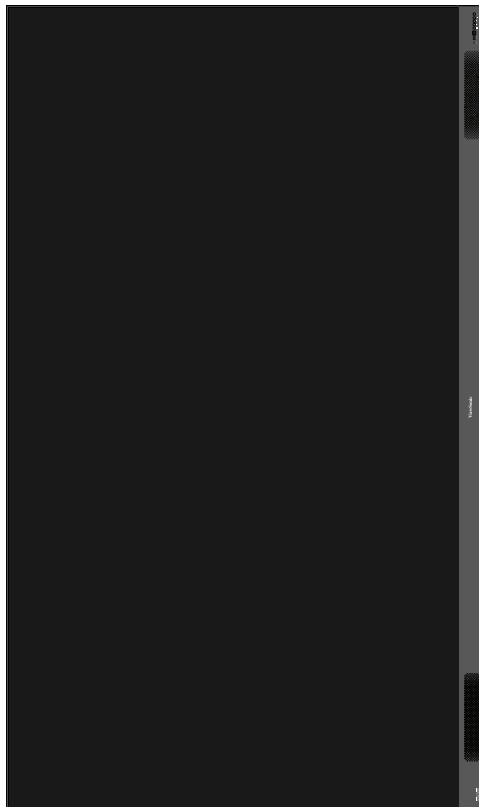

Portrait Installation

NOTE: The *System Control Box* can be installed under the *Cabinets* (standard installation) for front access, or behind the *Cabinets*.

Wall Mounting

Installing the Wall Mount Brackets

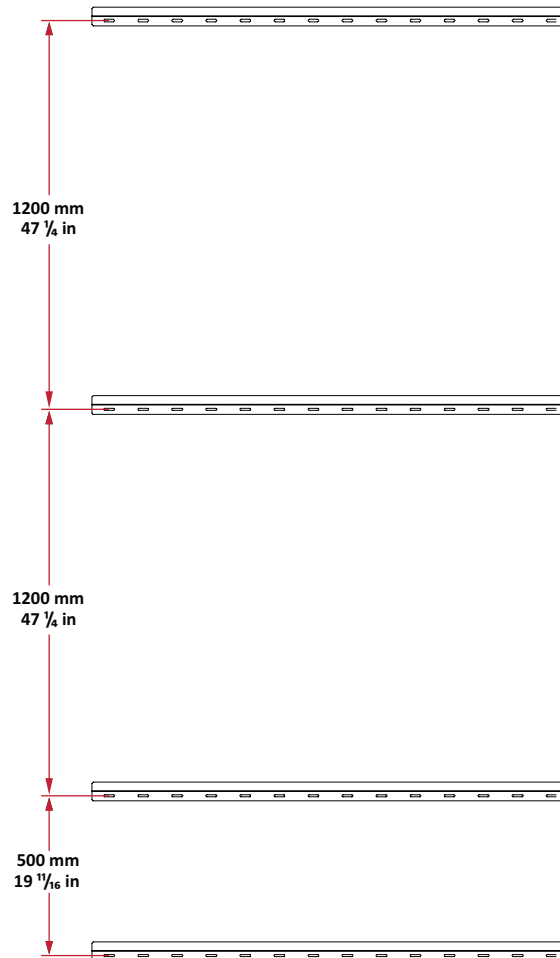

1. Ensure the wall area and size is an appropriate installation site.
 2. Using the first *Wall Mount Bracket*, install the top *Wall Mount Bracket* with the provided screws (M6x50mm Expansion for masonry; TA6x30mm for load bearing wood).
 3. Repeat **Step 2**, ensuring the second *Wall Mount Bracket* is level with the first *Wall Mount Bracket*. Keep a 47 1/4" (1200 mm) space between the two brackets (as pictured above).
 4. Install the remaining two *Wall Mount Brackets* in the same manner as the other two *Wall Mount Brackets*. The distance between the *Wall Mount Brackets* is 47 1/4" (1200 mm) and 19 11/16" (500 mm) respectively.
- ❗ Ensure the wall can safely support 297.62 lbs. (135 kg).
 - ❗ Ensure the deviation of the wall surface is $< 13/64$ " (< 5 mm).

Installing the Cabinets

1. Ensure 10 *Mounting Brackets* are attached to the rear of the five (5) Middle Cabinets are positioned horizontally as shown below:



2. Carefully lift each *Cabinet* up onto the *Wall Mount Brackets*, starting from the bottom.

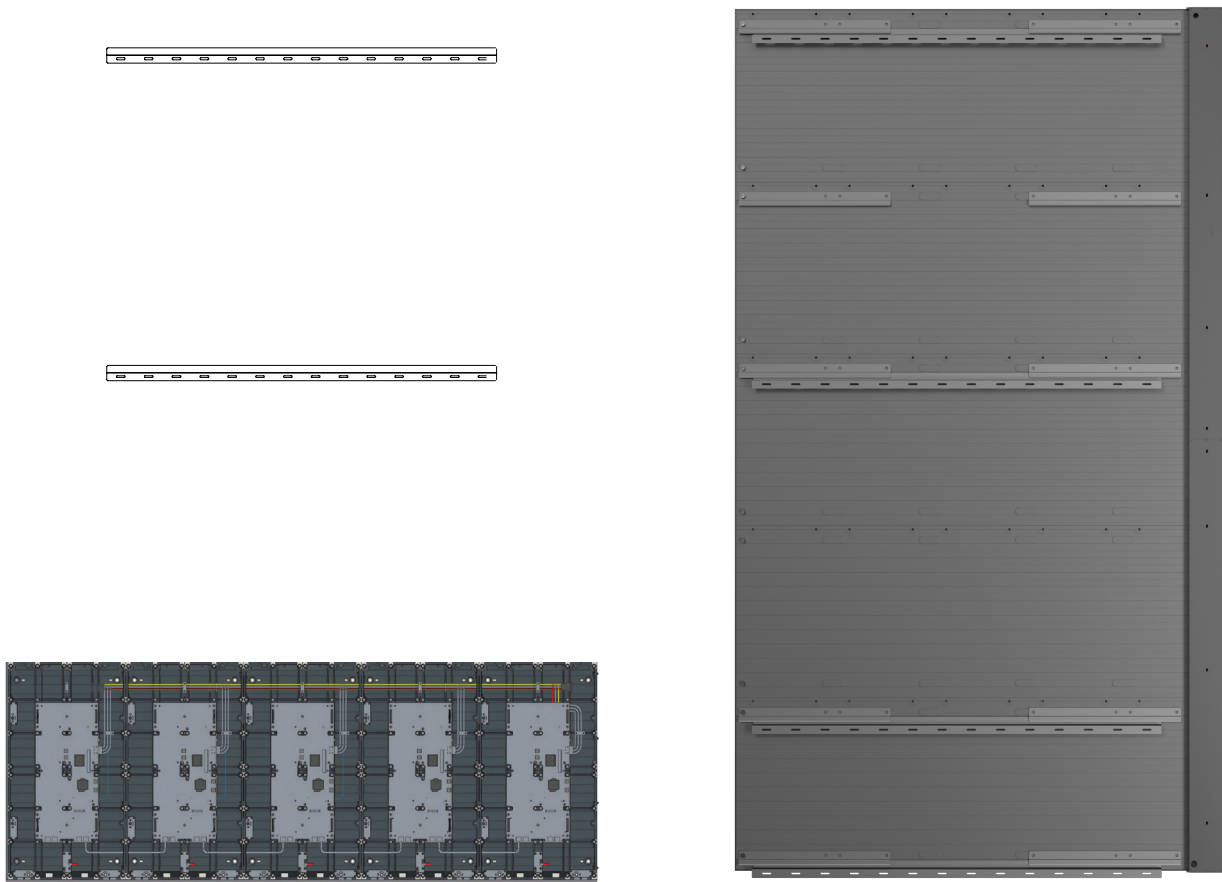

NOTE: *Cabinet* letter installation will differ based on the preferred *System Control Box* installation (left or right side).

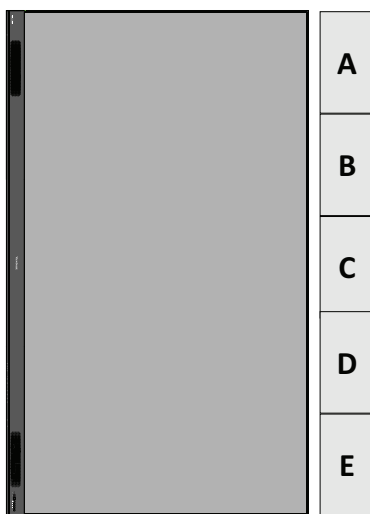

Left Side Installation

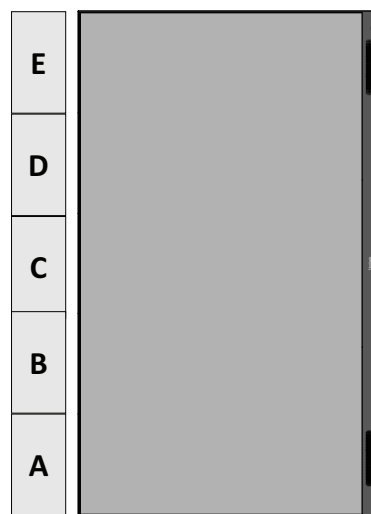

Right Side Installation

3. Ensure the *Mounting Brackets* sit securely on the *Wall Mount Brackets* as shown below.

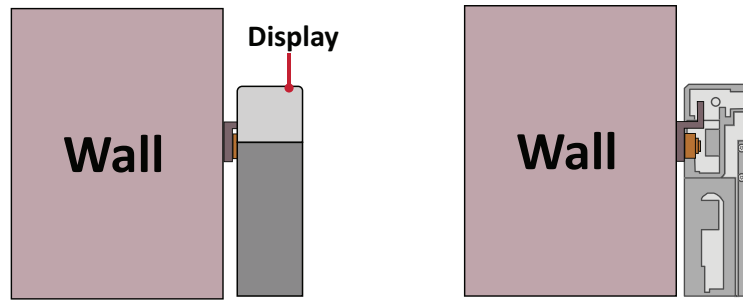

4. Push each *Locking Bolt* and lock each *Hook* with the hex tool to securely connect each cabinet together. It may be necessary to align the hole with an Allen wrench in order to engage the *Locking Bolt*.

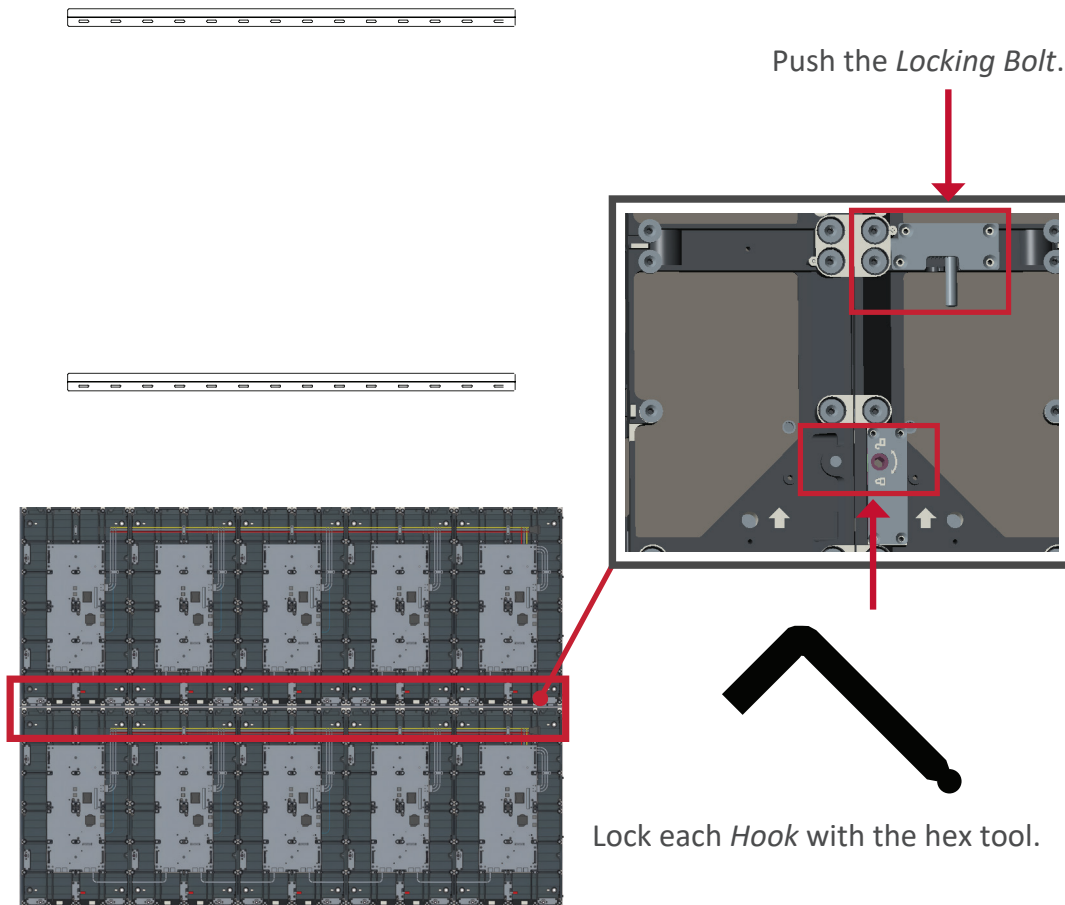

NOTE: There are five (5) *Locking Bolts* and 10 *Hooks* between each cabinet.

5. Further secure the *Cabinets* together with M6x16mm screws.

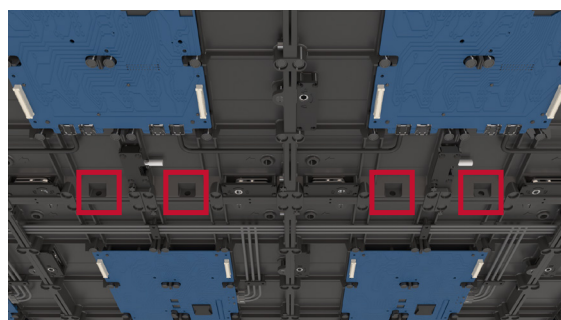

- Place the remaining *Cabinets* up onto the *Wall Mount Brackets*. Install from bottom to top, ensuring the *Mounting Brackets* sit securely on the *Wall Mount Brackets*.
- Repeat **Step 4**, securing the cabinets together with each *Locking Bolt* and *Hook*.

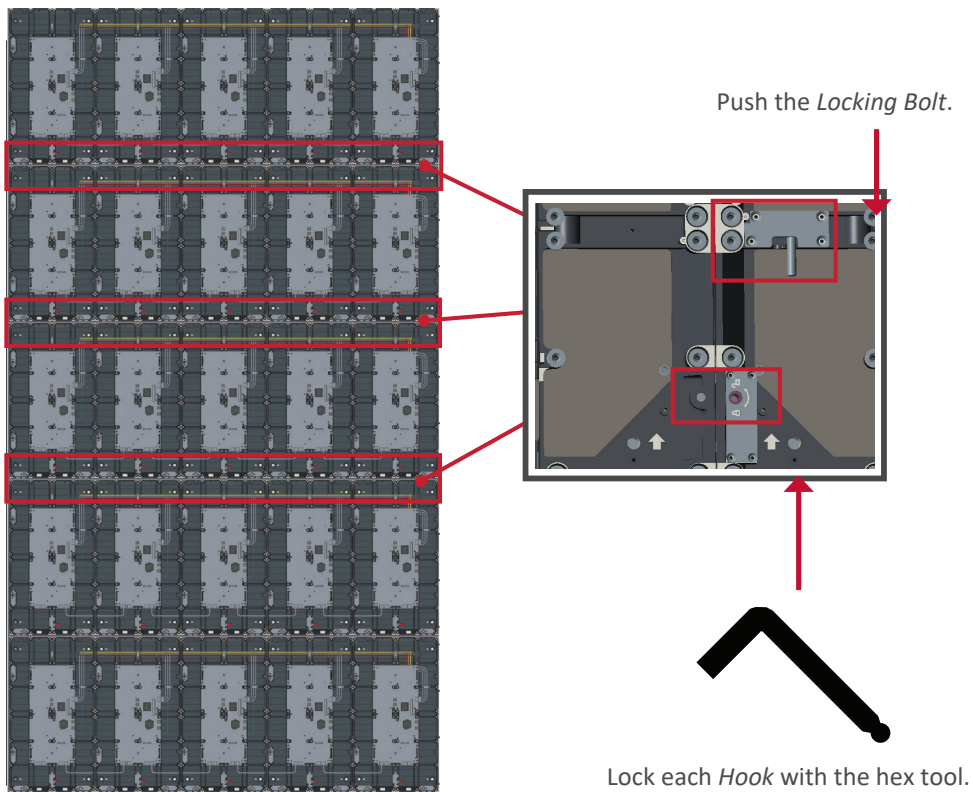

NOTE: There are five (5) *Locking Bolts* and 10 *Hooks* between each cabinet.

- Further secure the *Cabinets* together with M6x16mm screws.

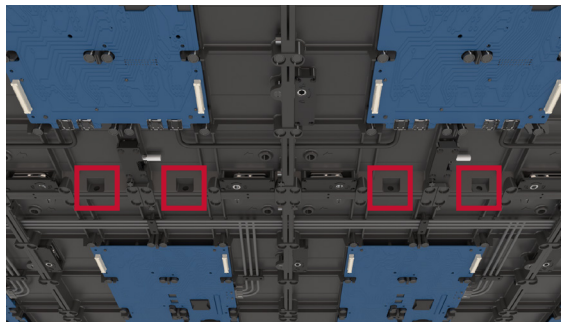

9. After installing all the *Cabinets*, the installation wall should look like:

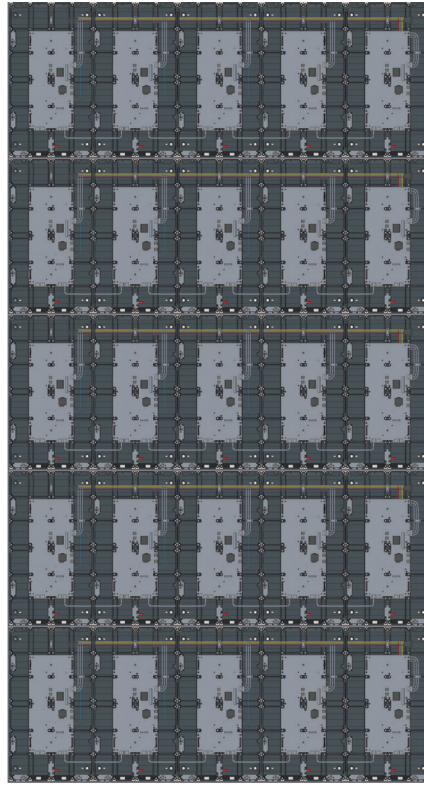

Connecting the System Control Box (Standard Installation)

1. Carefully unfold the *System Control Box* panel. Ensure the main system control board is on the right.

NOTE: Use caution as the *System Control Box* panel is separated into two pieces with wires attached.

2. Starting from the bottom, align the holes of the *Cabinet* with the *System Control Box* to attach.

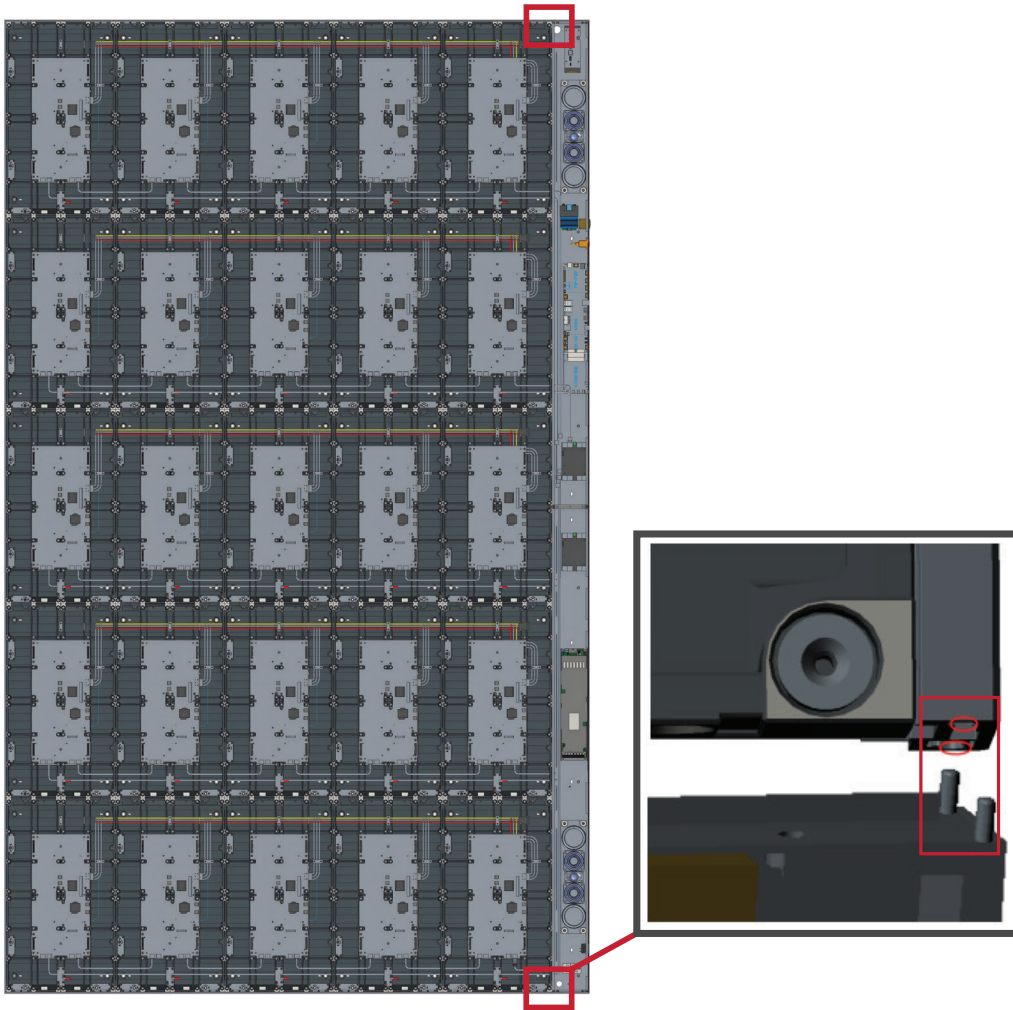

3. You can also reroute the power cable for cable management. Loosen the two (2) PWM 4x6mm screws, pull the power cable out, thread the power cable through the hole and then fasten the screws tightly.

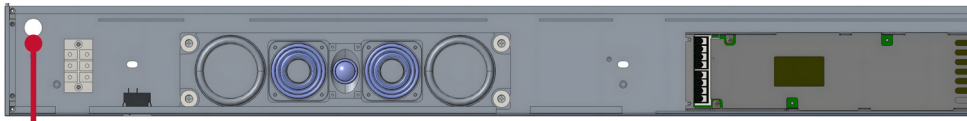

Hole for cable management

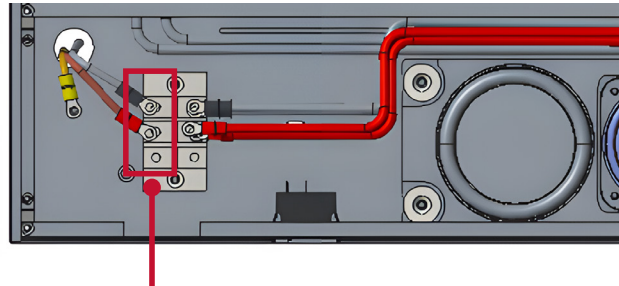

Two (2) PWM 4x6mm Screws

! Professional installation only.

4. Further secure the *System Control Box* to the *Cabinets* with the 20 provided M6x10mm screws.

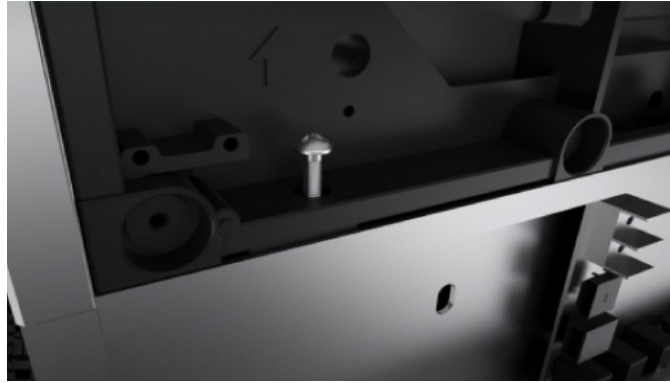

5. Connect the Network and Power cables of the *Cabinets* to the *System Control Box*.

NOTE: There are five (5) Network and five (5) Power cables to connect.

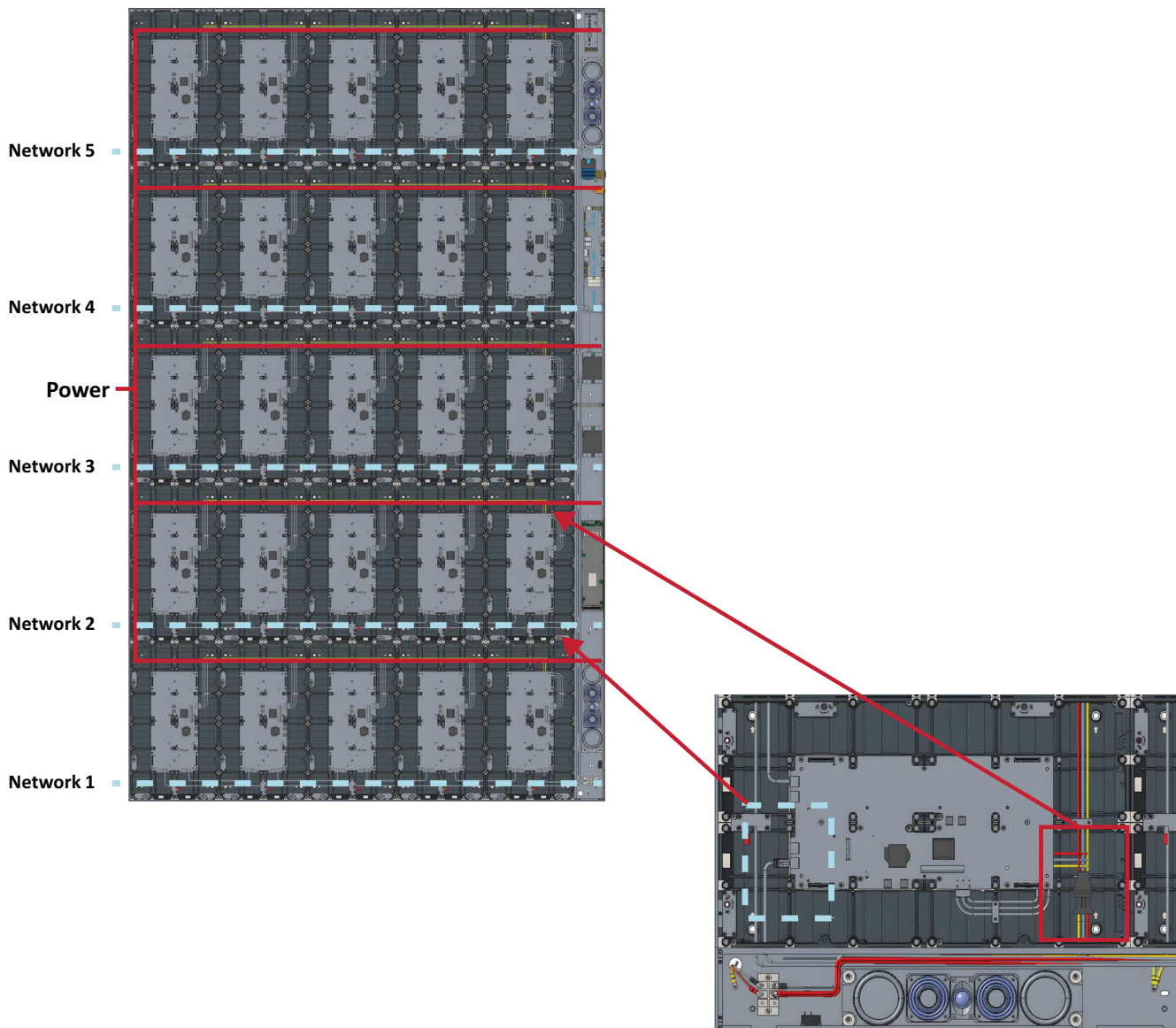

6. After installing the *System Control Box*, the installation wall should look like:

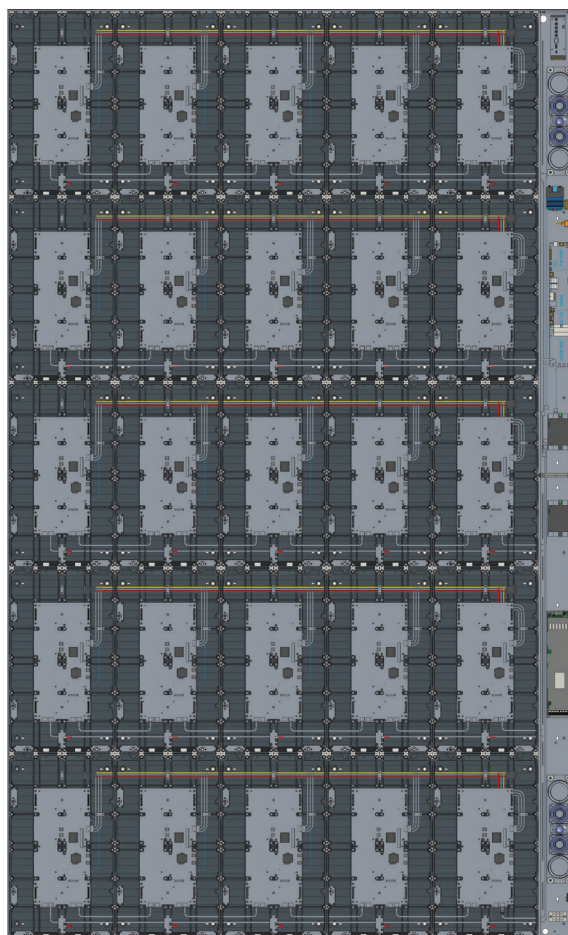

7. Install the *System Control Box Covers* with the KM3x6mm screws.

Connecting the System Control Box (Hidden Installation)

1. Carefully unfold the *System Control Box* panel. Ensure the main system control board is on the right.

NOTE: Use caution as the *System Control Box* panel is separated into two pieces with wires attached.

2. Install the left and right part of *System Control Box* using the M6x16mm screws behind the *Cabinet*.

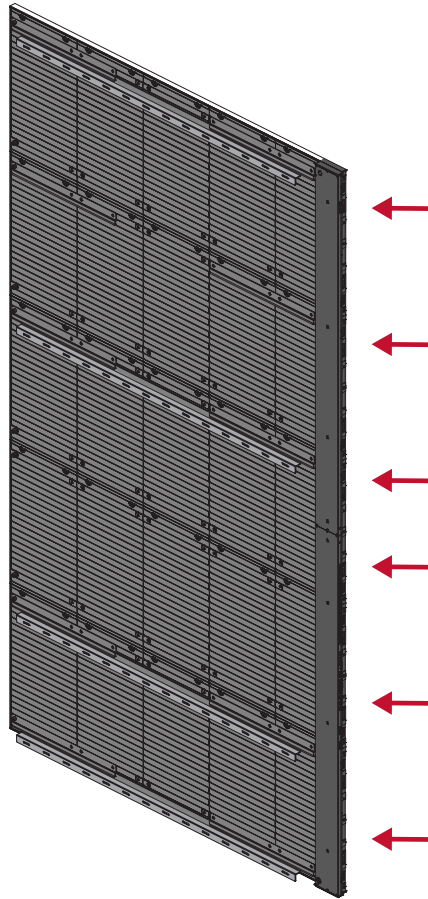

NOTE: The *System Control Box* can be installed on the left or right side behind the display.

3. Connect the Network and Power cables of the *Cabinets* to the *System Control Box*.

NOTE: There are five (5) Network and five (5) Power cables to connect.

- Route the Power cable through the opening provided in the *Cabinet* and connect it to the power plug.

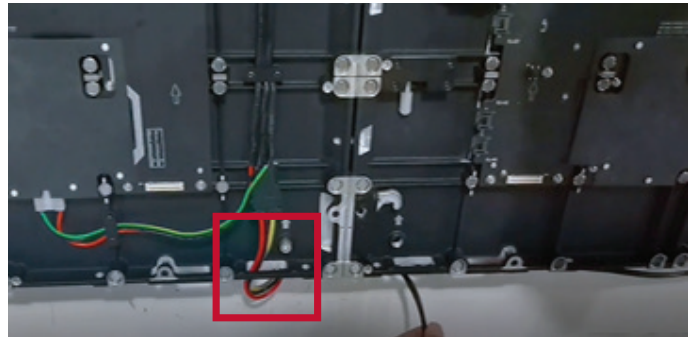
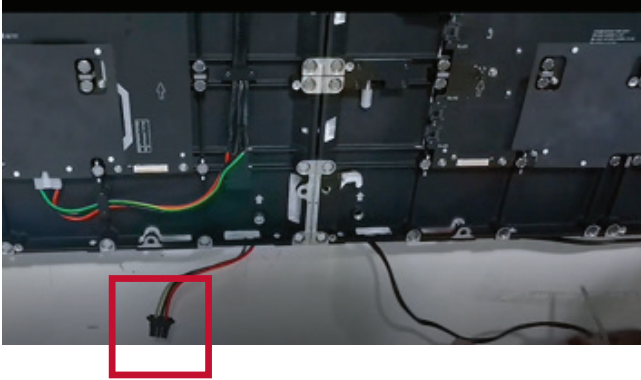

- Route the Network cable through the opening provided in the *Cabinet* into an "S-shape" and connect it to the network port.

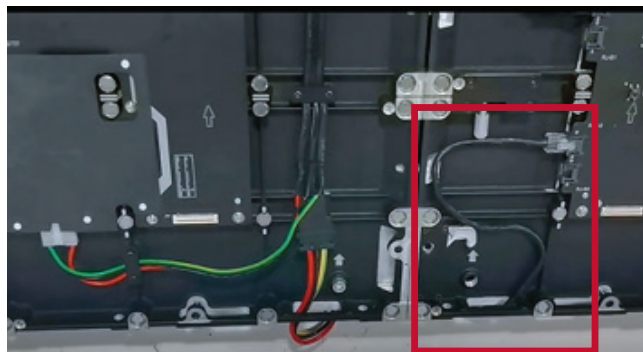

4. Install the bezels from the bottom of the screen and use the M6x10mm screws to secure it to the *Cabinet*.

Installing the LED Modules

1. Install each *LED Module* onto the *Cabinets* from bottom left to right, being sure to match the corresponding numbers on the *Module* to the *Cabinet*.

NOTE: *LED Module* installation will vary depending on the location of the *System Control Box*.

⚠ Please wear Anti-Static Gloves before handling the LED modules.

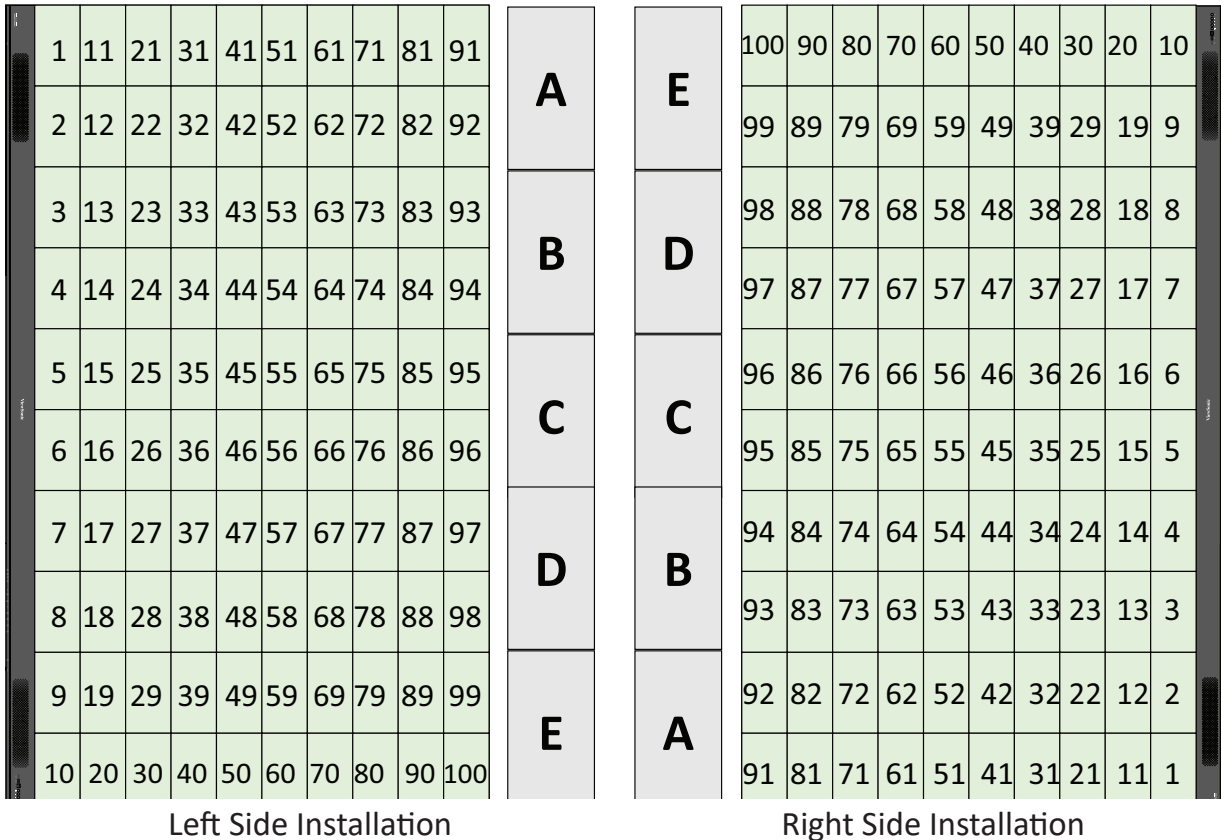

2. Ensure each *Module* is flush and that there is little to no gap between each. It may be necessary to gently tap the module to make it flush.

3. After installing the *LED Modules*, the installation wall should look like:

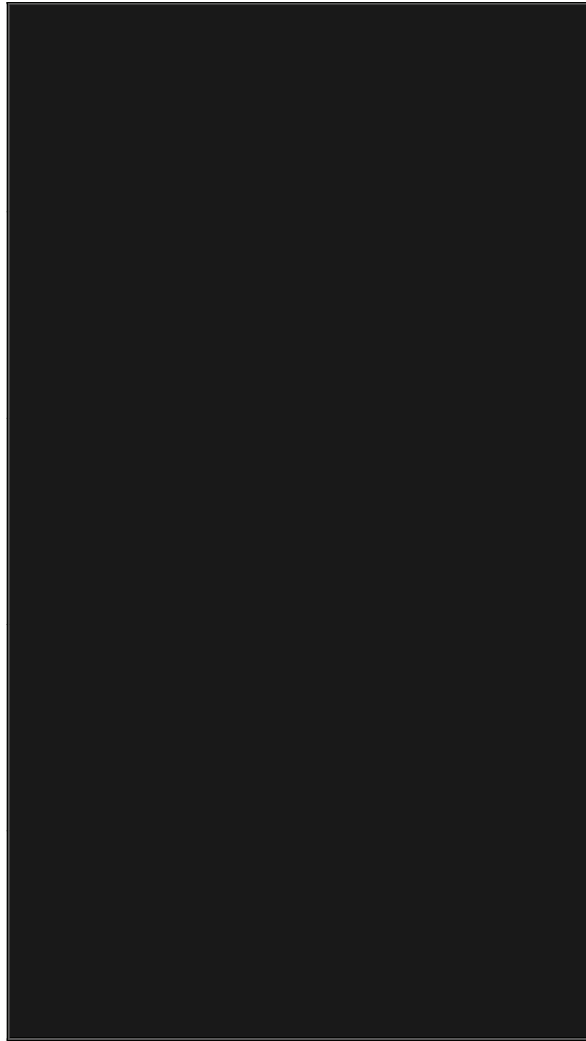

NOTE: The lowest *Wall Mount Bracket* can be removed for a cleaner installation.

Making Connections

Connecting to External Devices

HDMI IN Connection

Media Player Connection

Connect an HDMI cable from your external device to an **HDMI IN** port on the LED display.

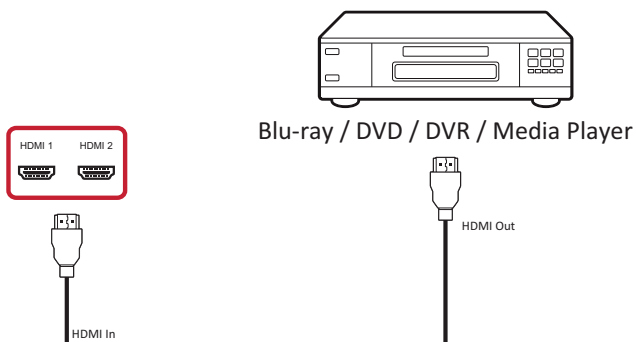

PC Connection

Connect an HDMI cable from your PC to an **HDMI IN** port on the LED display.

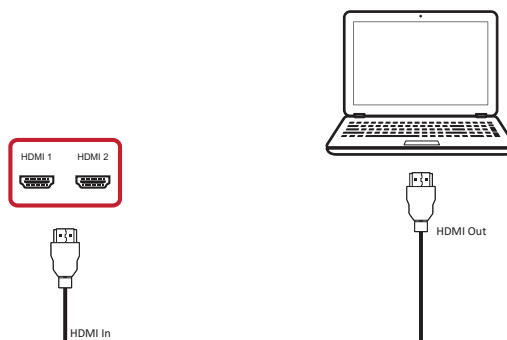

Audio Connection

Connect an audio cable from your external audio device to the **Audio Out** port on the LED display.

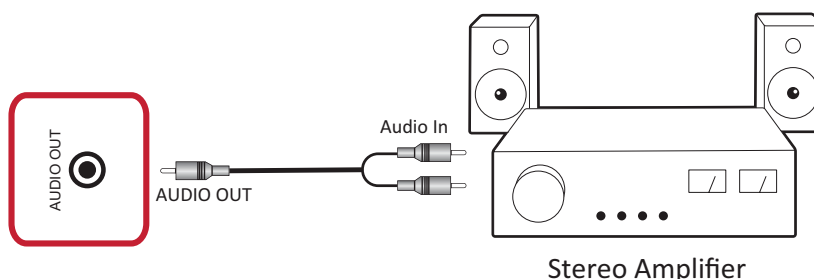

HDBaseT Connection

Connect a CAT5e/6 cable from your external device to the HDBaseT device before installing the *System Control Box Cover*.

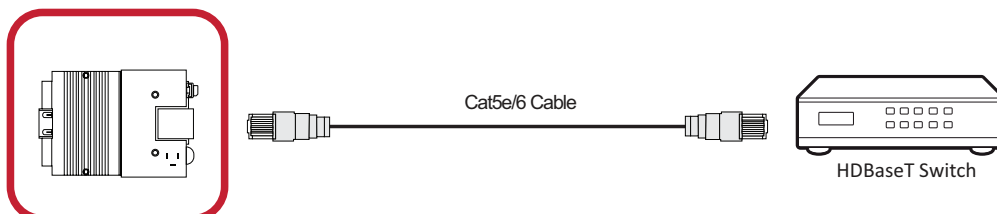

Video Output Connection

To output video via an external display device, connect an HDMI cable to the **HDMI IN** port of your external display device, and the other end to the **HDMI OUT** port of your LED display.

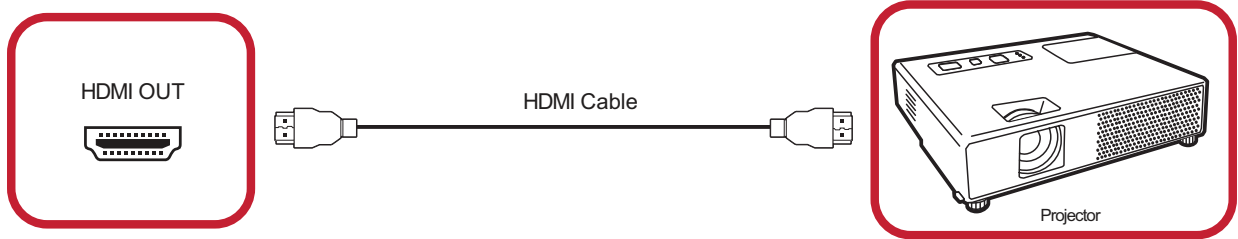

USB and Networking Connections

Just like any PC, it is easy to connect various USB devices and other peripherals to your LED display.

USB (Type A / Type C)

- USB Type A

Plug the USB device, cable, or storage drive into the **USB Type A** port.

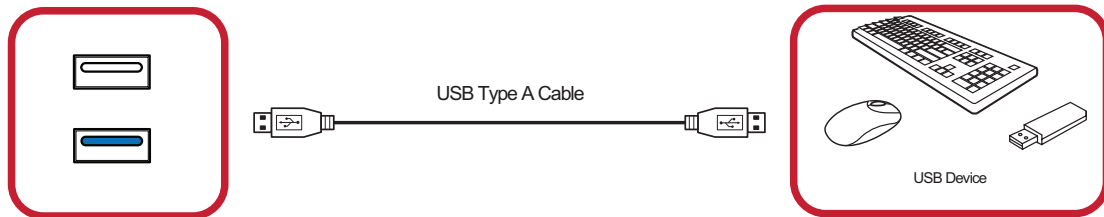

- USB Type C

Plug the USB device, cable, or storage drive into the **USB Type C** port.

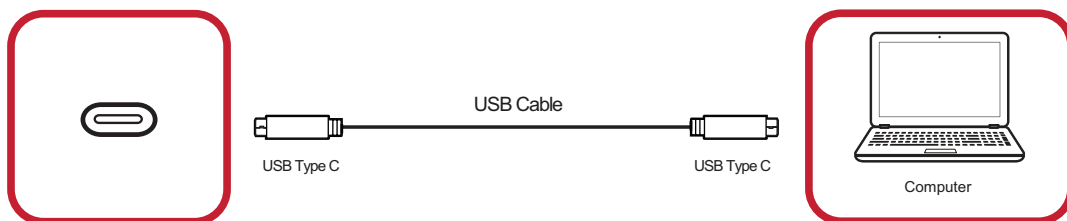

Networking and Modem cables

Plug the network cable into the **LAN** port.

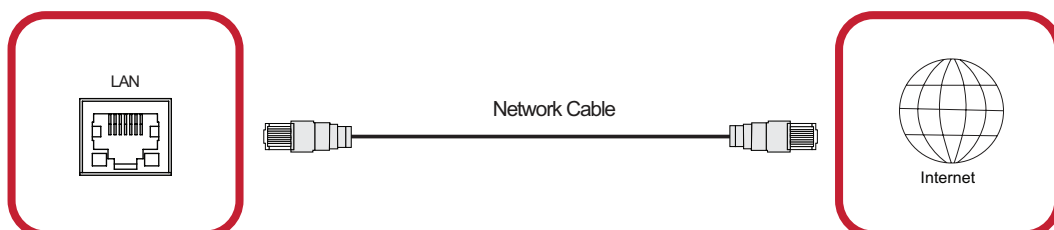

RS-232 Connection

When you use a RS-232 serial cable to connect your LED display to an external computer and control system certain functions can be controlled remotely such as: Power On/Off, Volume adjustment, Input select, Brightness, and more.

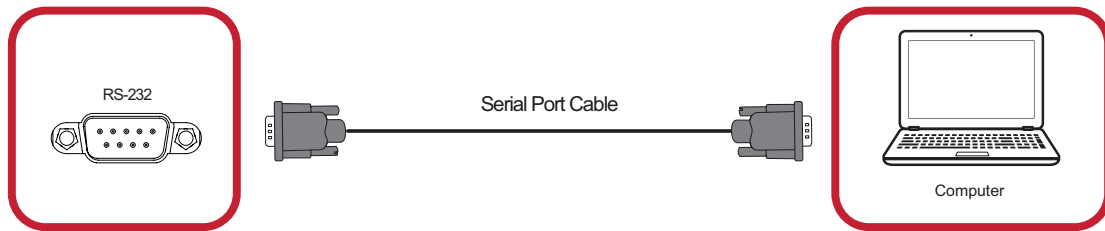

Using Your Display



Powering On/Off your LED Display

1. Ensure the power cord is connected and plugged into a power outlet.
2. Press the **Power Switch** to the ON position.



Power Switch

The  **Power** button is located on the front of the unit.

3. Press the  **Power** button to turn on the LED display.
4. To turn the display off, press the  **Power** button again.

Home Screen



Number	Item	Description
1	Main Menu	Access the Home Screen, APP Center, Settings, and Input Source .
2	Time of Day Indicator	The sky will change over the day between morning, noon, afternoon, and night.
3	Quick Access	Quick access to LAN, Wi-Fi, Brightness, and Power. NOTE: Only supported by keyboard and mouse.
4	Date & Time	Automatic time adjustment, time zone selection, and 24-hour format can all be adjusted on page 106. The Date & Time can also be hidden from the Home Screen under: Settings > Display > Launcher Settings
5	ViewSonic Logo	The logo can be hidden from the Home Screen under: Settings > Display > Launcher Settings

Navigating the Home Screen

Remote Control

The remote control can be used to easily navigate the Home Screen. When using the remote control, ensure it is kept within the IR receiver range as shown below:

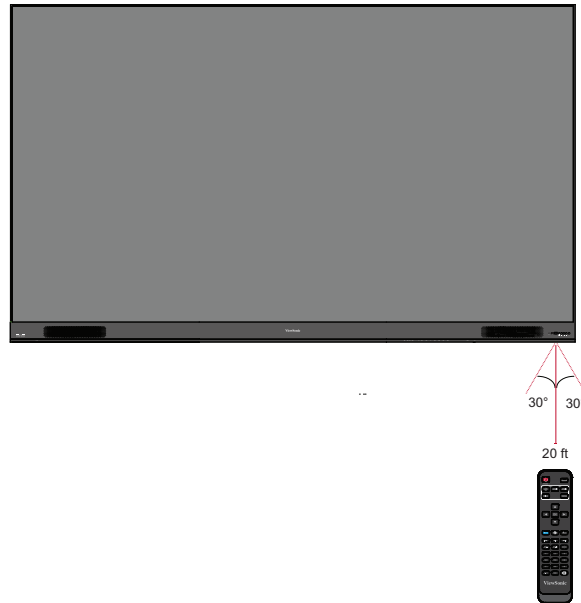

Keyboard and Mouse

When connected to the USB Type-A port of the display, a keyboard and mouse can also be used to navigate the Home Screen.

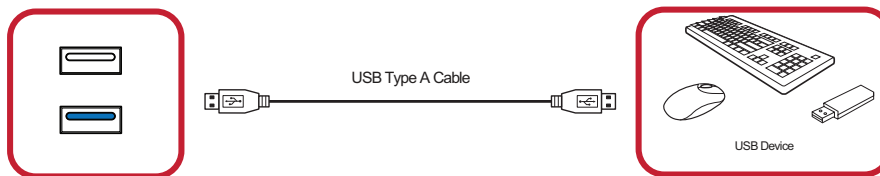

The mouse pointer will appear as an orange dot on the display when used:

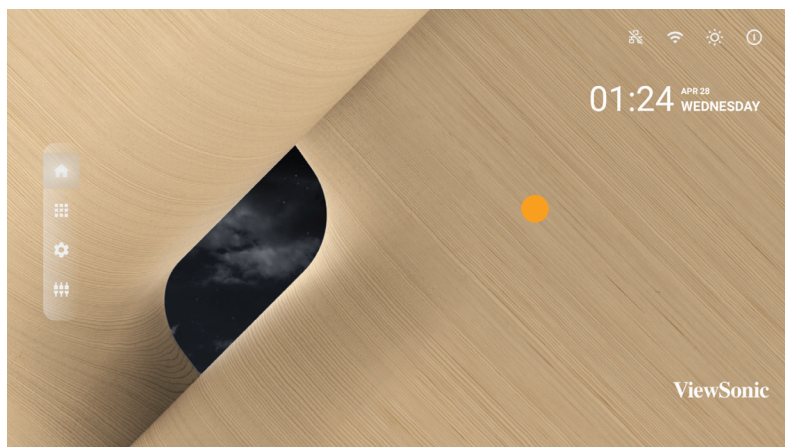







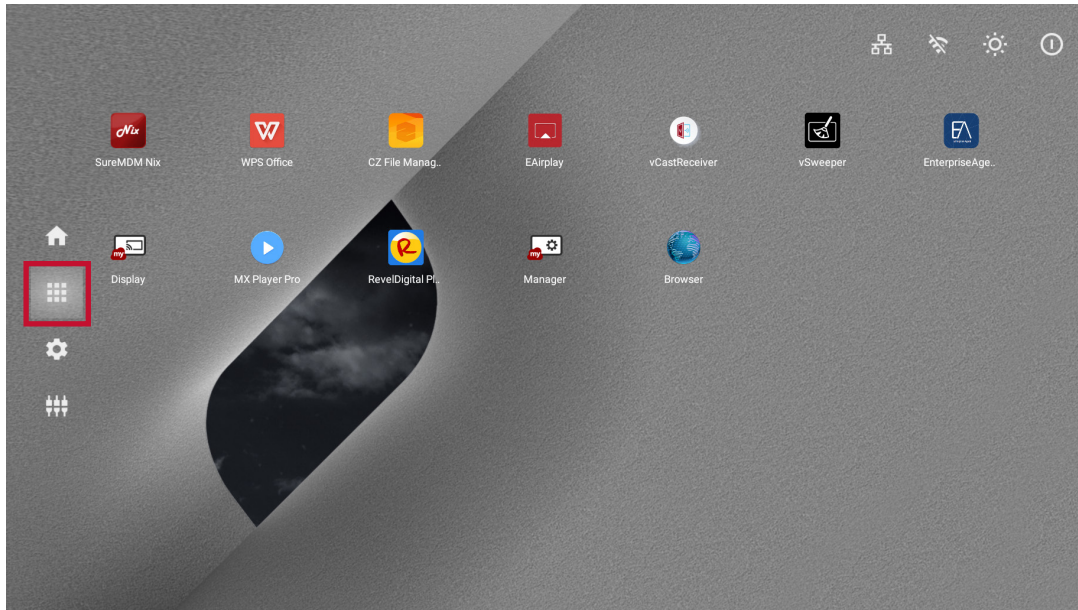



- The left mouse button will confirm actions.
- The right mouse button will go back to the previous layer.
- Keyboard shortcuts and hot keys are also supported, including: audio adjustment, mute, and back to the Home Screen.

APP Center

Installed applications will be in the APP Center.



Icon	Name	Description
	Browser	Web browser
	Display	Wirelessly mirror your desktop
	EAirplay	AirPlay mirroring
	EnterpriseAgent	Device management
	File Manager	File explorer
	Manager	Remote device management
	Revel Digital Signage	Manage digital signage
	SureMDM Nix	Secure, monitor, and manage devices
	WPS Office	Create documents, spreadsheets, and presentations
	vCastReceiver	Receive casted content from devices
	vSweeper	Clear up storage space

NOTE: Preloaded applications are subject to change without notice.

Input Source

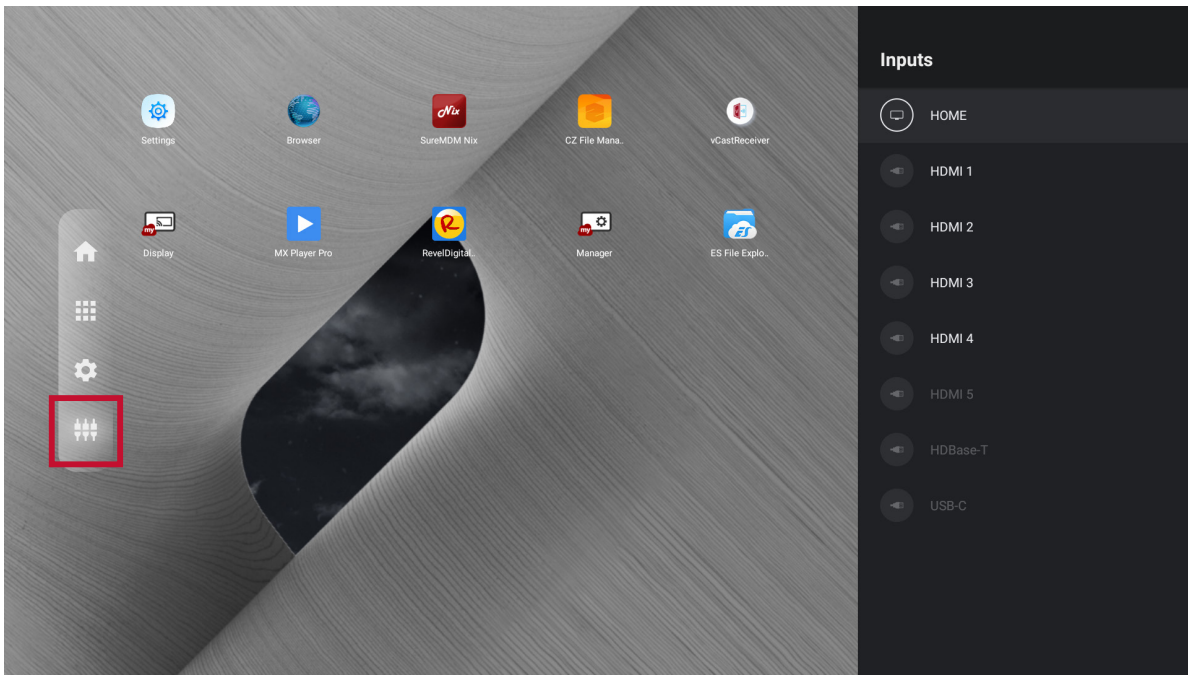

The display supports eight input sources: **Home**, **HDMI 1**, **HDMI 2**, **HDMI 3**, **HDMI 4**, **HDMI 5**, **HDBaseT**, and **USB C**.

Settings

Adjust and view the display's settings.

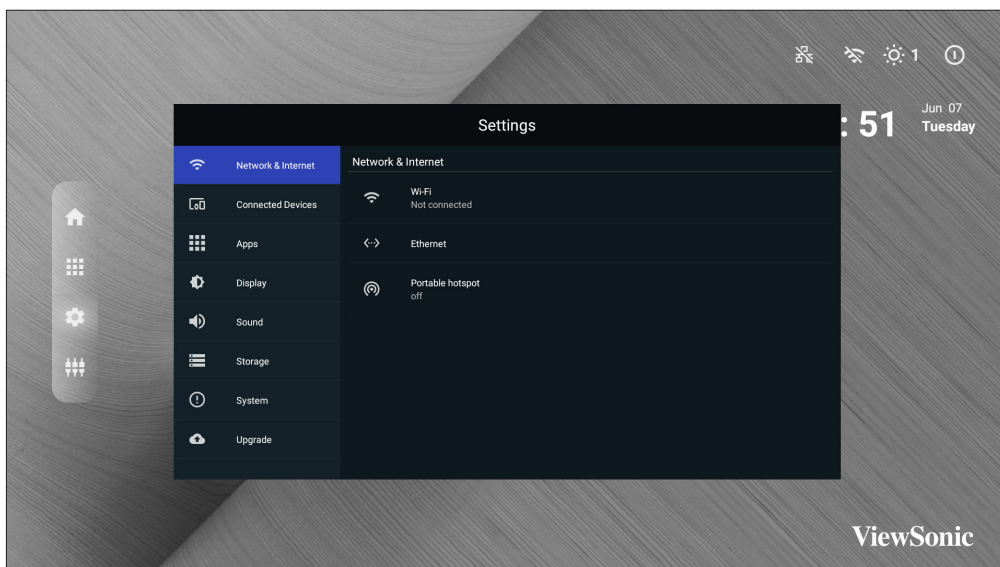
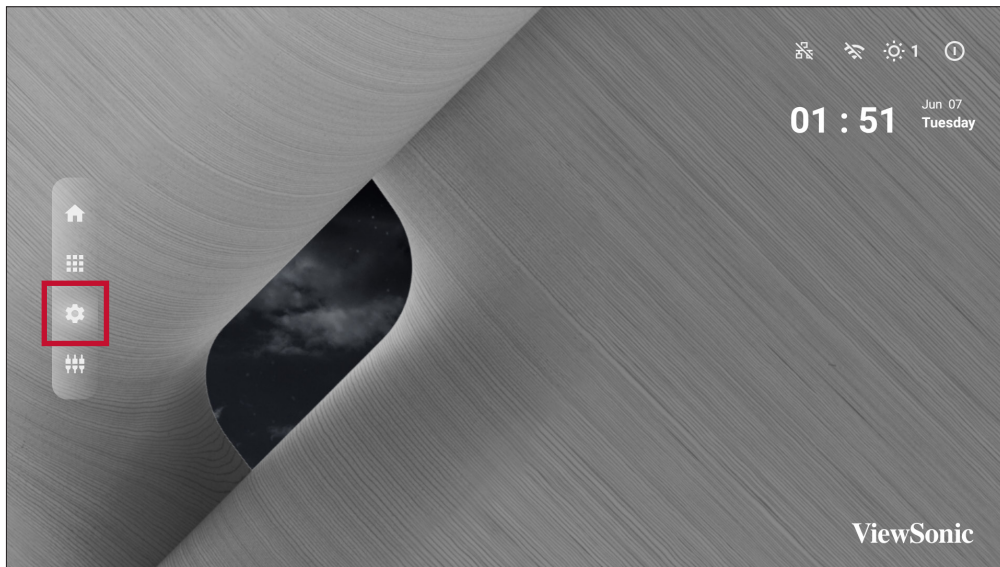

Menu	Description
Network & Internet	View and adjust Wi-Fi, Ethernet, and Potable Hotspot.
Connected Devices	View and adjust Connected Devices.
Apps	View and adjust App Info., App Permissions, and Default Apps.
Display	View and adjust Brightness Level, Ambient Light Sensor, Font Size, Startup & Shutdown, Input Setting, and Launcher Settings.
Sound	View and adjust Media Volume.
Storage	View and adjust Device Storage.
System	View and adjust Languages & Input, Date & Time, Dehumidification, Reset, and About Device.
Upgrade	View and adjust OTA Upgrade and Local Update.

Settings Menu Tree

Main Menu	Sub-menu	Menu Option			
Network & Internet	Wi-Fi	Wi-Fi	On		
			Off		
		Wi-Fi List	Add Network		
		Wi-Fi Preference	Open Network Notification		On
					Off
			Keep Wi-Fi on During Sleep		
		Advanced			
	Ethernet	Ethernet IP Mode	DHCP		
			STATIC		
		Ethernet Details			
Portable Hotspot	Portable Wi-Fi Hotspot	On			
		Off			
Connected Devices	Connected Devices	On			
		Off			
	Device Name	ViewSoinc DVLED			
Apps	App Info.	Installed Apps	Disable		
			Force Stop		
	App Permissions	Calendar			
		Location			
		Microphone			
		Storage			
	Default Apps	Browser			
Home					
Display	Brightness Level	(-/+ , 1~8)			
	Ambient Light Sensor	On			
		Off			
	Font Size	(-/+ , 1~4)			
	Dual-Screen Splicing	Enable	On		
			Off		
	Startup & Shutdown	Splash Screen	Default		
			ViewSonic		
Black					
Blue					

Main Menu	Sub-menu	Menu Option		
Display	Startup & Shutdown	Last Shutdown Channel	On	
			Off	
		Default Startup Channel	Home	
			HDMI 1	
			HDMI 2	
			HDMI 3	
			HDMI 4	
			HDMI 5	
			USB C	
			HDBaseT	
			APP (Display)	
			APP (vCastReceiver)	
		Standby Mode	Hibernate	
			Sleep	
		Splash Screen	ViewSonic	
	Black			
	Blue			
	Input Setting	Input Alias	HDMI 1	Display
				Hide
			HDMI 2	Display
				Hide
			HDMI 3	Display
			HDMI 4	Hide
			HDMI 5	Display
		USB C	Hide	
		HDBaseT	Display	
		Signal Source Detect	Enable	
	Disable			
Launcher Settings	ViewSonic Logo	On		
		Off		
	Date & Time	On		
		Off		
	Theme			
Other Display Settings	Custom Resolution	Width		
		Height		

Main Menu	Sub-menu	Menu Option		
Display	Other Display Settings	Custom DPI	(-/+ , 100~240)	
		Custom Wallpaper		
	Boot Logo Settings			
Sound	Media Volume	(-/+ , 0~100)		
Storage	Device Storage	Internal Shared Storage	Storage Manager	On Off
			Photos & Videos	
			Music & Audio	
			Games	
			Movie & TV	
System	Language & Input	Languages	English	
			French	
			Spanish	
			German	
			Russian	
			Dutch	
			繁体中文	
			简体中文	
			Turkish	
			Arabic	
	Timer Setting	Shutdown Time	Remote Controller Input Method	
			Manage Keyboards	
			Repeat	Off Once Everyday
		Time		

Main Menu	Sub-menu	Menu Option			
System	Timer Setting	Power On Time	Repeat	Off	
				Once	
				Everyday	
			Time		
		Sleep Timer	Off/1/10/20/30/40/50/60/90/120 minute(s)		
		Power Saving	On		
			Off		
	Standby Mode	Hibernate			
		Sleep			
	Date & Time	Automatic Date & Time	On		
			Off		
		Select Time Zone			
		Use 24-hour Format	On		
	Off				
	Dehumidification	Settings	On		
			Off		
		Automatic Reminders	On		
			Off		
		Begin Dehumidification Now	On		
			Off		
		Scheduled	On		
	Off				
	Reset	Network Settings Reset			
		Reset App Preferences			
		Factory Data Reset			
	About Device	Status			
		Legal Information			
Model					
Kernel Version					
Build Number					
Total Time					

Main Menu	Sub-menu	Menu Option	
Upgrade	OTA Upgrade	OTA Cloud Server	
	Local Update	sda1	
		SDcard	

Network & Internet

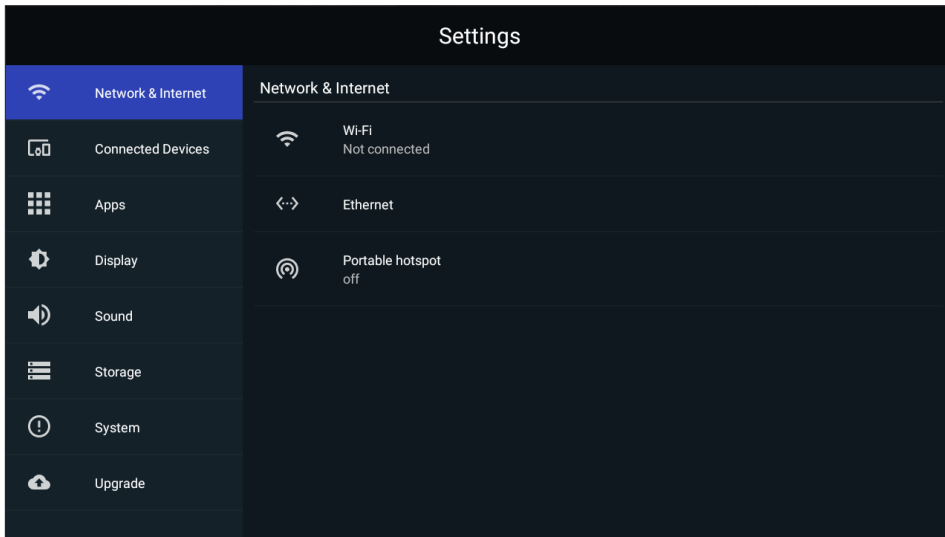

Sub-menu	Description
----------	-------------

Select **Wi-Fi** to enter the Wi-Fi selection interface. Then select the desired Wi-Fi network and enter the password.

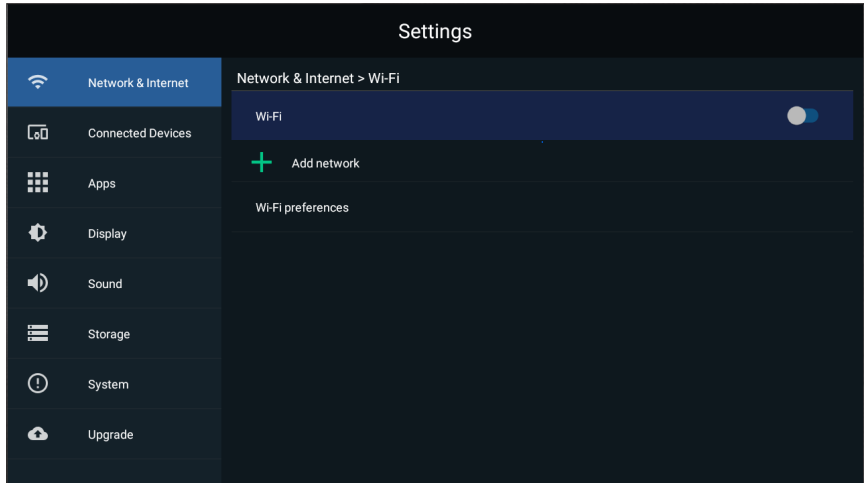

Wi-Fi

You can select **Add Network** in the Wi-Fi selection screen to manually add a Wi-Fi network.

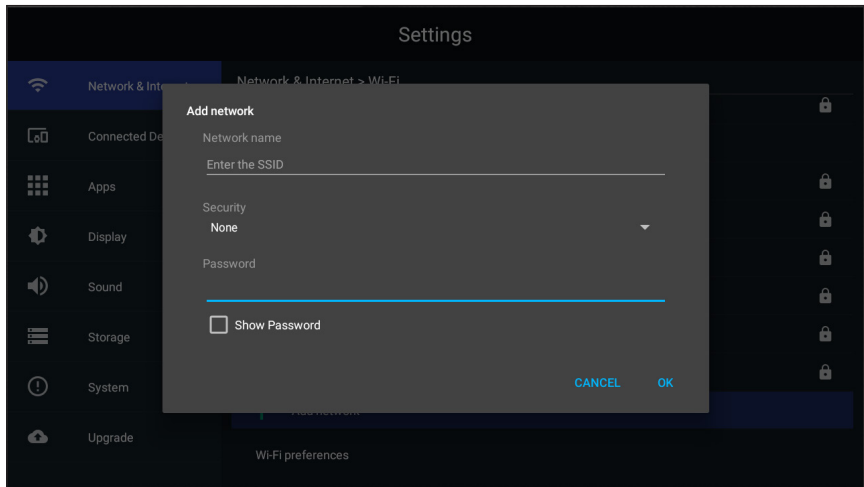

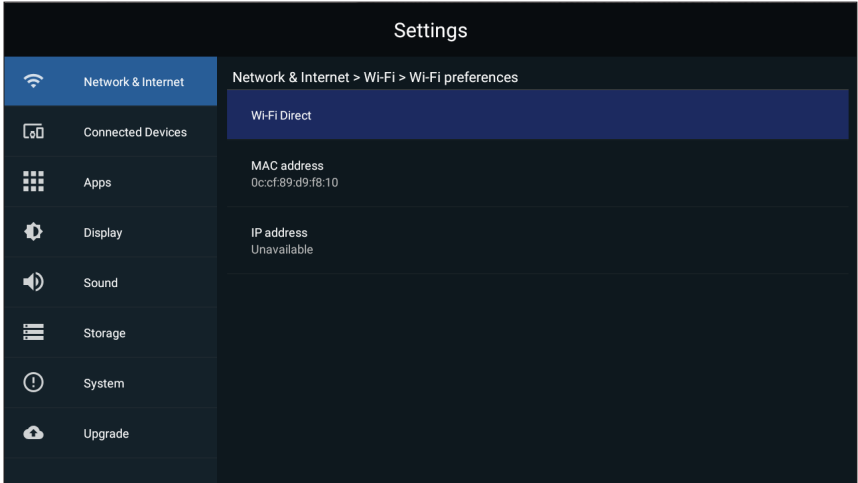
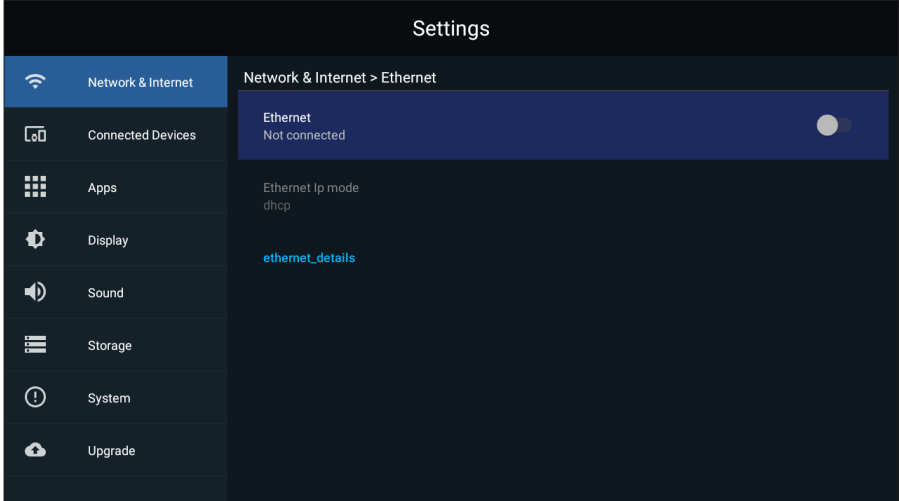
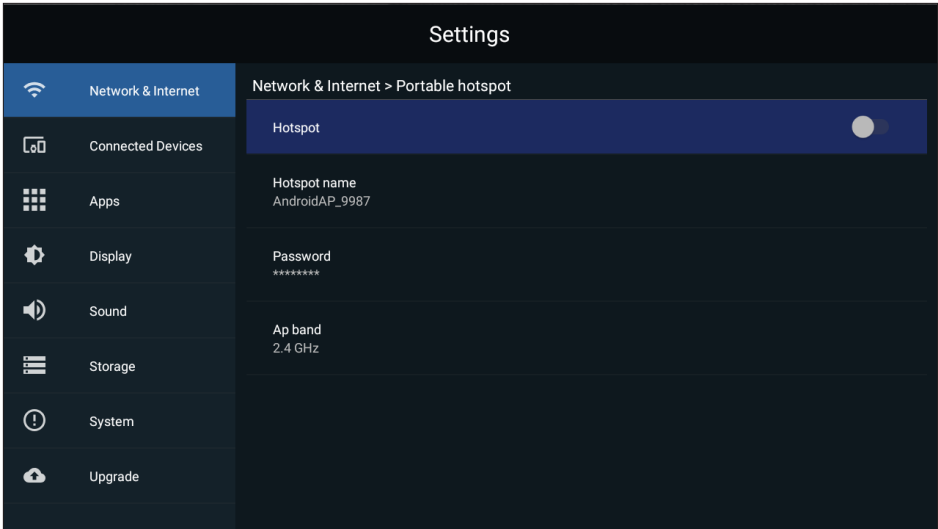
Sub-menu	Description
<p style="text-align: center;">Wi-Fi</p>	<p>Select Wi-Fi Preferences to view Wi-Fi usage preferences, Wi-Fi connection tips, etc.</p> 
<p style="text-align: center;">Ethernet</p>	<p>Select Ethernet to enable/disable Ethernet, review DNS, and IP mode.</p> 
<p style="text-align: center;">Portable Hotspot</p>	<p>Enable/disable Portable Wi-Fi Hotspot under Portable Hotspot.</p> 

Connected Devices

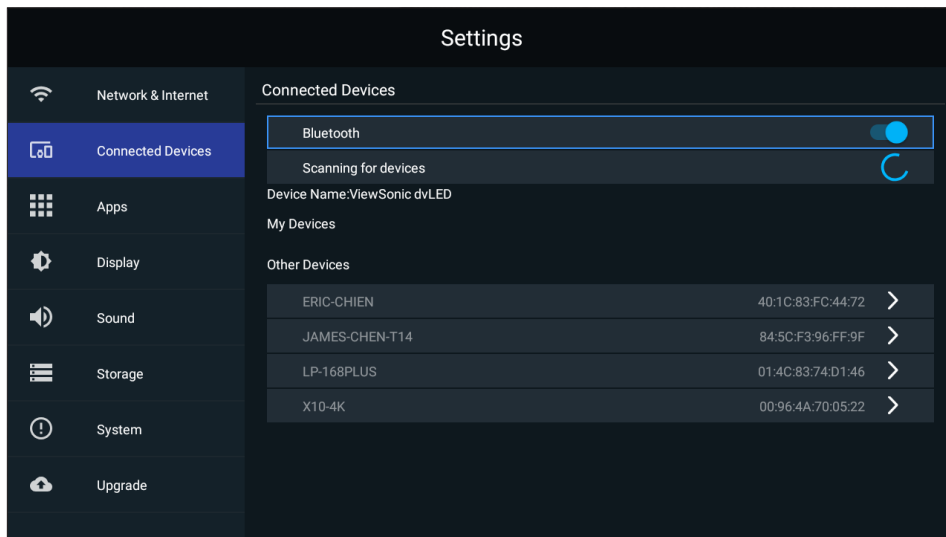

Enable/disable device connection, review connected devices, and search and connect to other devices.

Apps

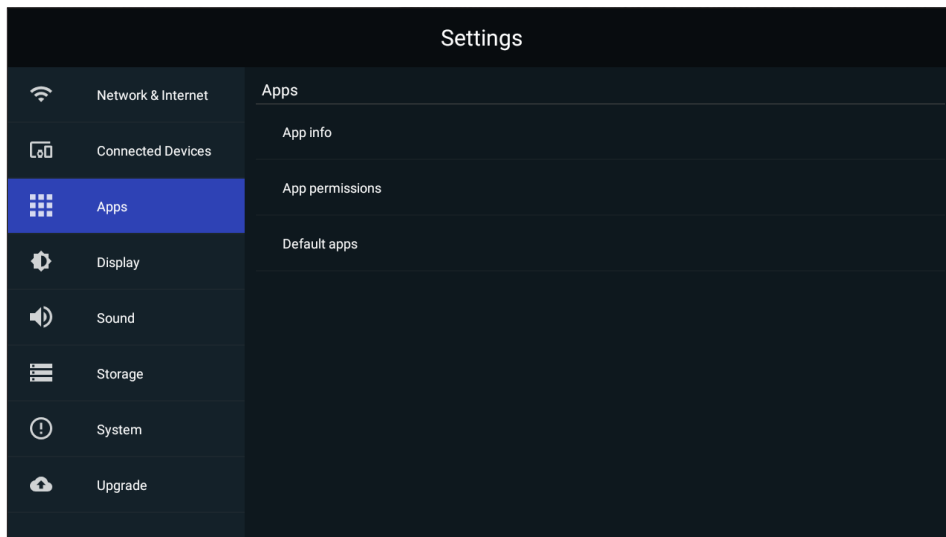

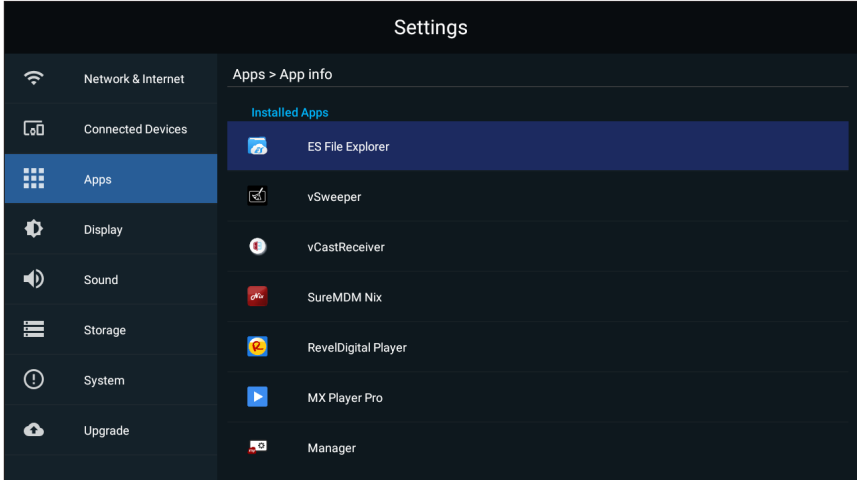
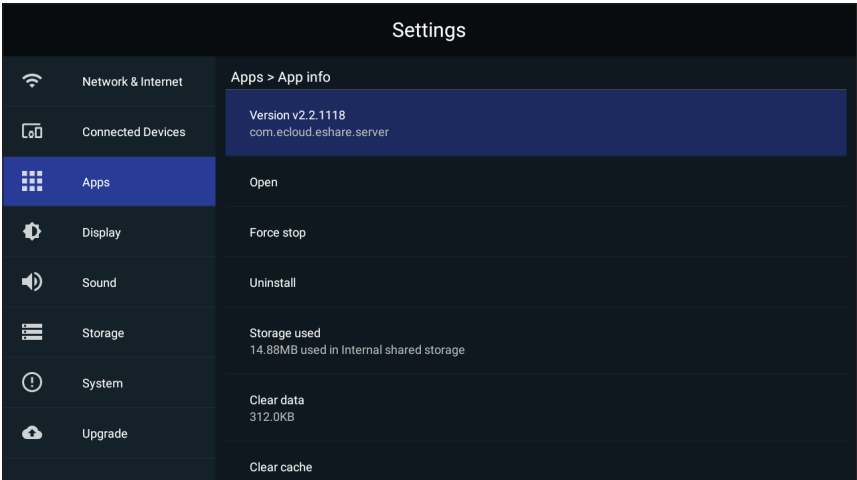
Sub-menu	Description
<p>App Info.</p>	<p>Select App Info to view installed applications and their detailed information.</p>  <p>You can also disable the application, review notifications and permissions, and adjust further settings.</p> 

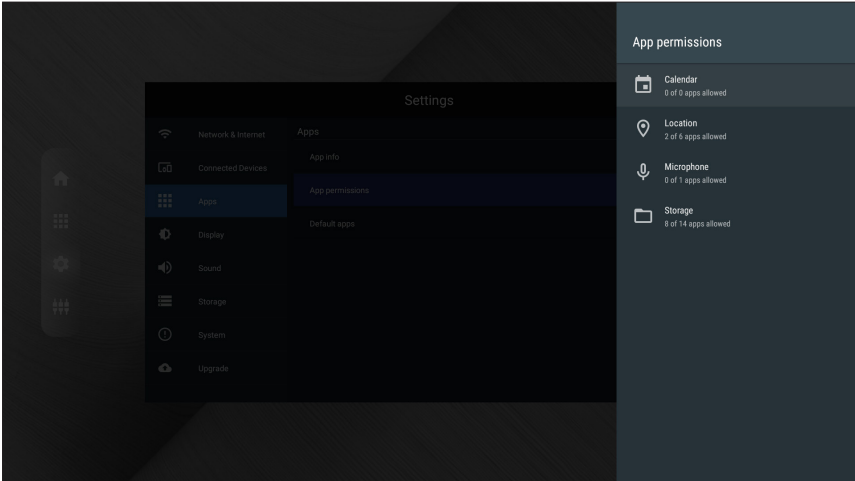
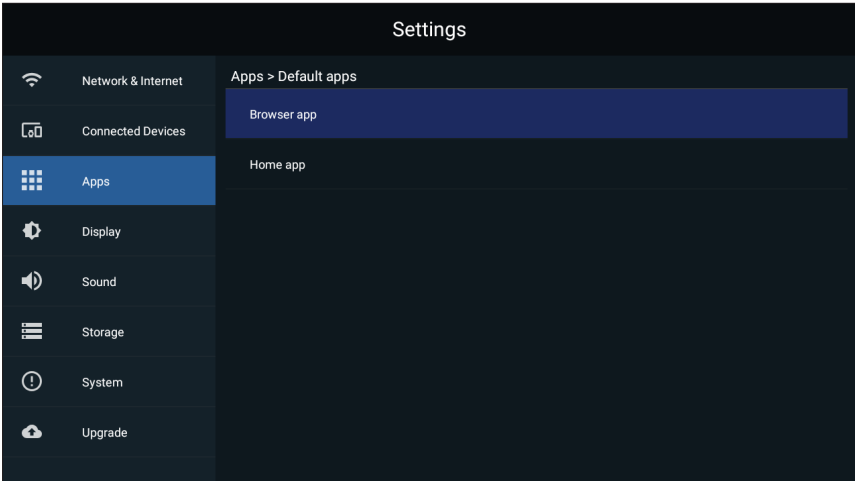
Sub-menu	Description
<p data-bbox="225 454 483 488">App Permissions</p>	<p data-bbox="576 181 1342 255">Select App Permissions to manage various application permissions.</p>  <p>The screenshot shows the Windows Settings application. The 'Settings' title is at the top. On the left, a navigation pane lists categories: Network & Internet, Connected Devices, Apps (highlighted), Display, Sound, Storage, System, and Upgrade. The main area shows 'App info' with sub-options for 'App permissions' and 'Default apps'. On the right, a sidebar titled 'App permissions' lists: Calendar (0 of 0 apps allowed), Location (2 of 6 apps allowed), Microphone (0 of 1 apps allowed), and Storage (8 of 14 apps allowed).</p>
<p data-bbox="252 1025 456 1059">Default Apps</p>	<p data-bbox="576 772 1027 806">Select your default applications.</p>  <p>The screenshot shows the Windows Settings application. The 'Settings' title is at the top. On the left, a navigation pane lists categories: Network & Internet, Connected Devices, Apps (highlighted), Display, Sound, Storage, System, and Upgrade. The main area shows 'Apps > Default apps'. It lists 'Browser app' (highlighted) and 'Home app'.</p>

Display

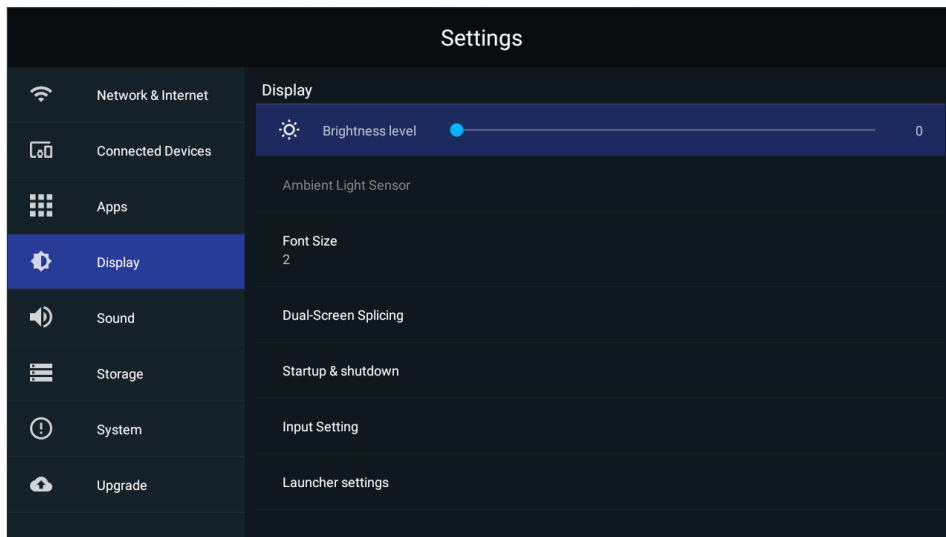

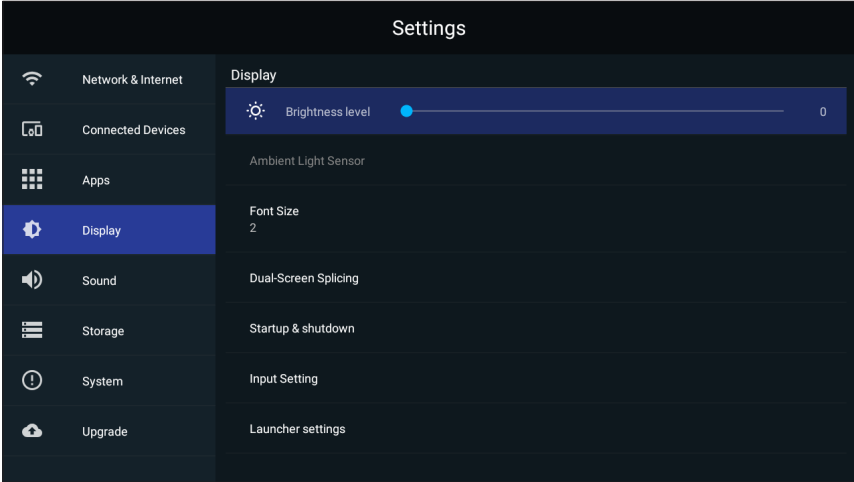
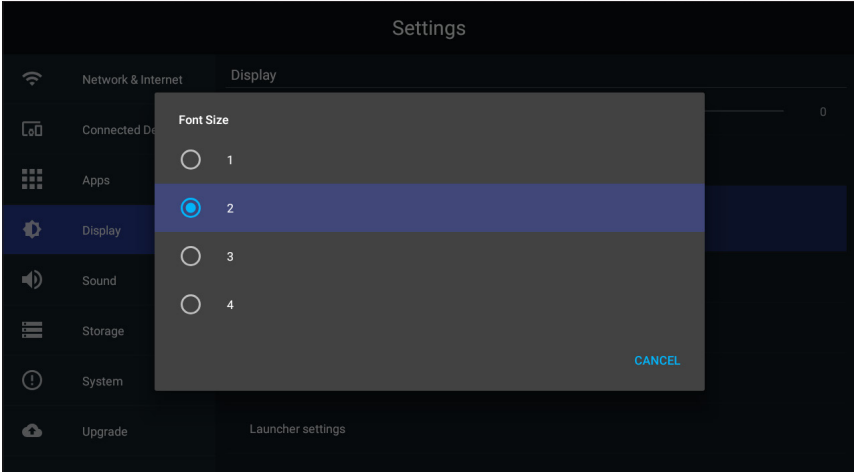
Sub-menu	Description
<p>Brightness Level</p>	<p>Adjust the brightness level by eight (8) levels.</p> 
<p>Ambient Light Sensor</p>	<p>Detects ambient light and adjusts brightness levels automatically.</p>
<p>Font Size</p>	<p>Preview and adjust the font size on the display.</p> 

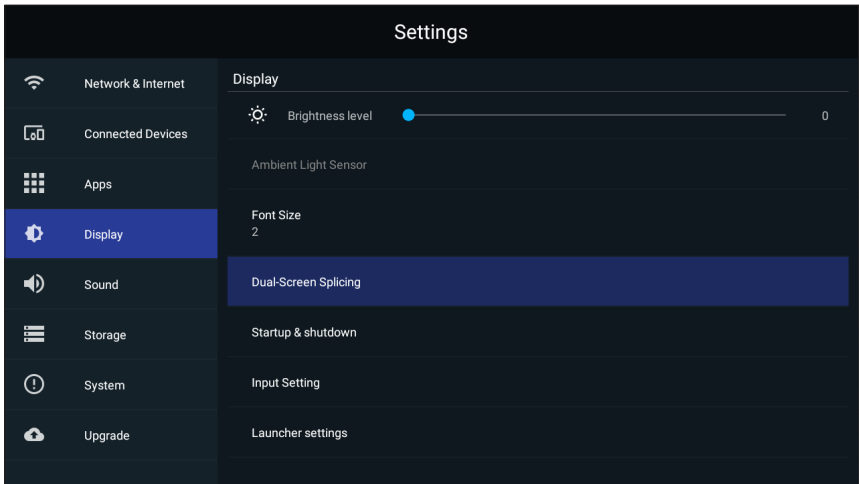
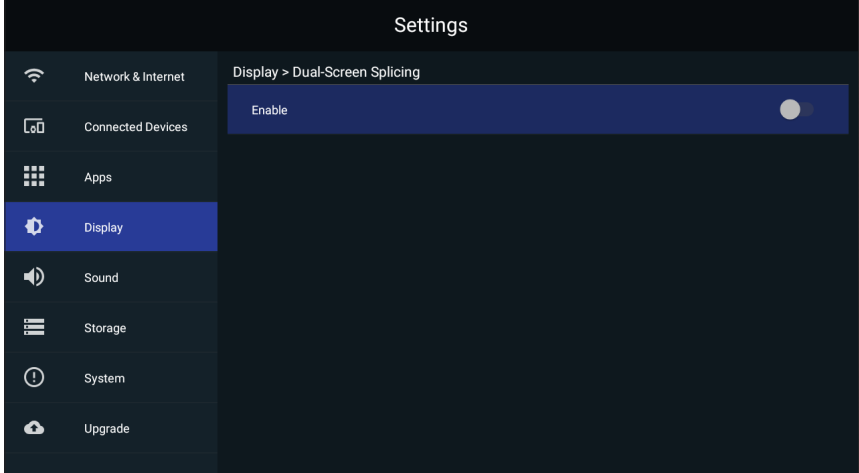
Sub-menu	Description
<p style="text-align: center;">Dual-Screen Splicing</p>	<p>Enable Dual-Screen Splicing if installing two (2) DirectView LED Displays together.</p>  

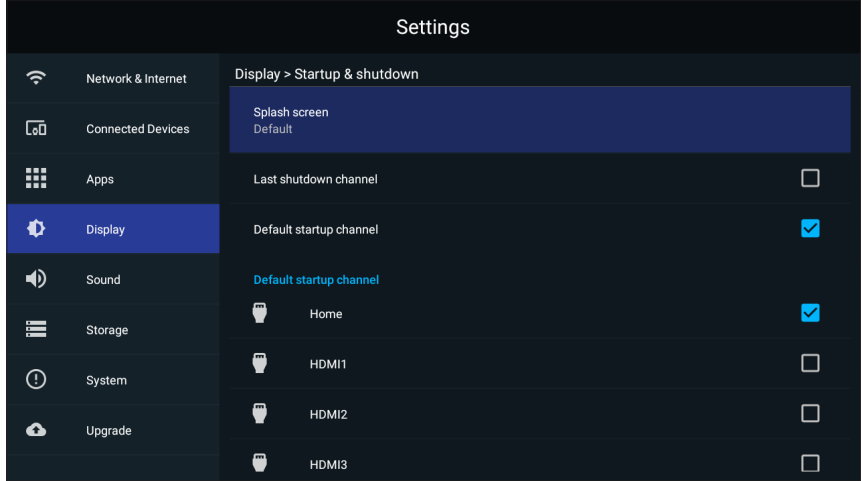
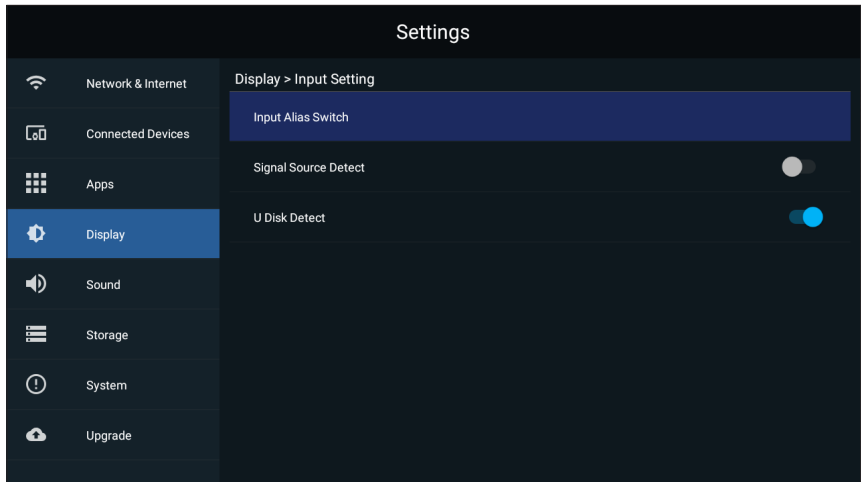
Sub-menu	Description
<p>Startup & Shutdown</p>	 <p><u>Startup Channel</u></p> <p>Last Shutdown Channel: Start in the channel that was last used before the previous shutdown.</p> <p>Default Startup Channel: Select a specific startup channel (Home, HDMI 1/2/3/4/5, HDBaseT, USB C, APP(Display), APP(vCastReceiver)).</p> <p><u>Standby Mode</u></p> <p>Hibernate: Power off the screen only.</p> <p>Sleep: Power down the display to minimal power consumption (0.5W).</p> <p><u>Splash Screen</u></p> <p>Change the boot screen to black, blue, or the ViewSonic logo.</p>
<p>Input Setting</p>	 <p><u>Input Alias Switch</u></p> <p>Display or hide the input source.</p> <p><u>Signal Source Detect</u></p> <p>Enable or disable HDMI input detection.</p> <p><u>U Disk Detect</u></p> <p>Enable or disable U Disk input detection.</p>

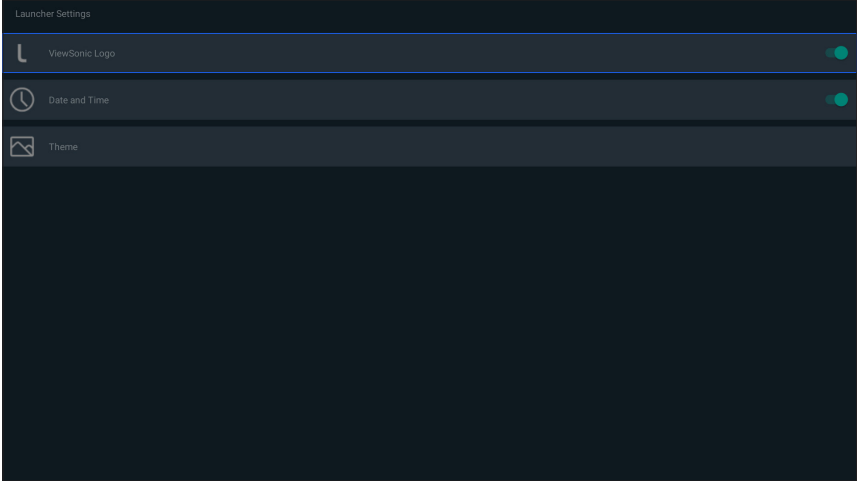
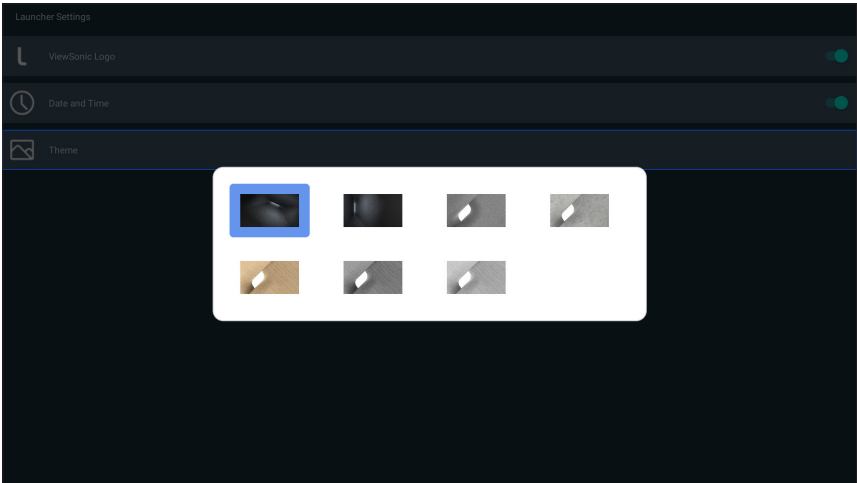
Sub-menu	Description
<p>Launcher Settings</p>	 <p><u>ViewSonic Logo</u> Display or hide the ViewSoinc logo on the Home Screen.</p> <p><u>Date & Time</u> Display or hide the date and time on the Home Screen.</p> <p><u>Theme</u> Choose from seven (7) included themes for the Home Screen.</p> 
<p>Others Display Settings</p>	<p>Adjust the Resolution, DPI, wallpaper and other display settings.</p>

Sound

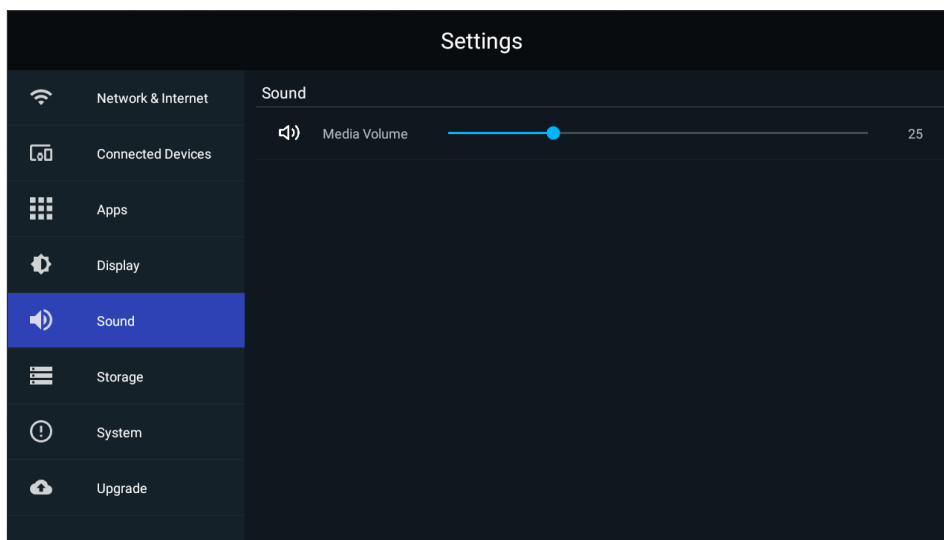

Sub-menu	Description
Media Volume	Adjust the volume level of the display.

Storage

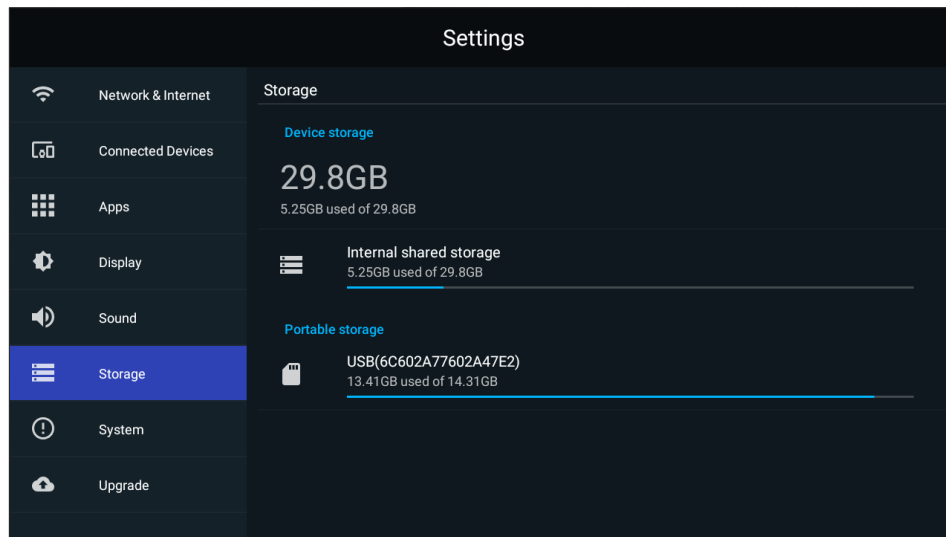

Sub-menu	Description
Internal Shared Storage	Internal storage allocation.

System

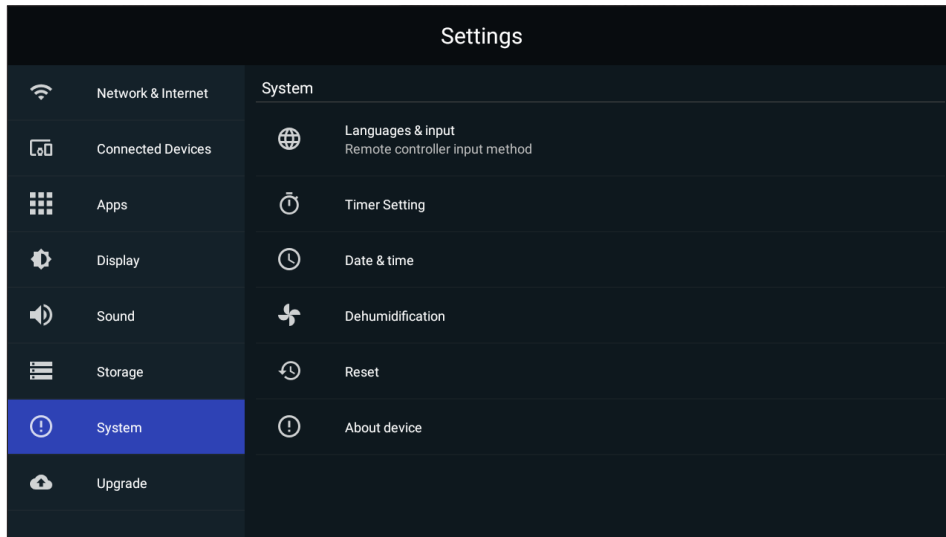

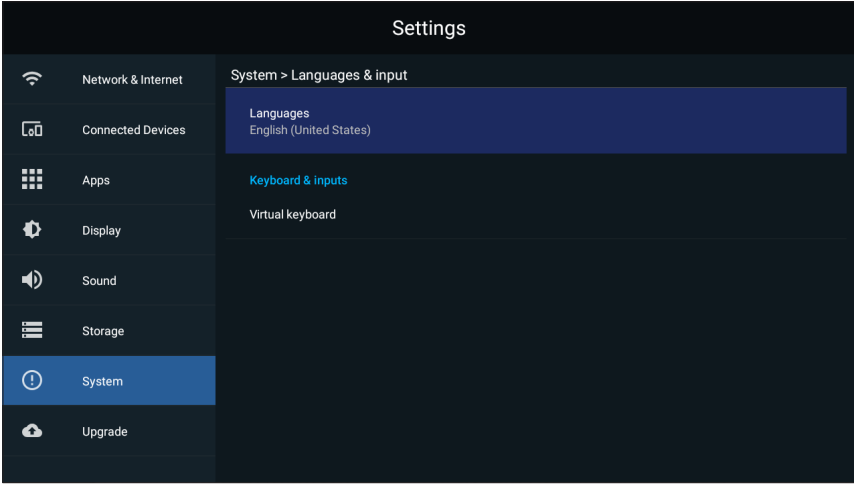
Sub-menu	Description
<p data-bbox="209 1111 499 1144">Languages & Input</p>	 <p data-bbox="576 1294 871 1368"><u>Languages</u> Language selection.</p> <p data-bbox="576 1391 959 1464"><u>Virtual Keyboard</u> Select your input method.</p>

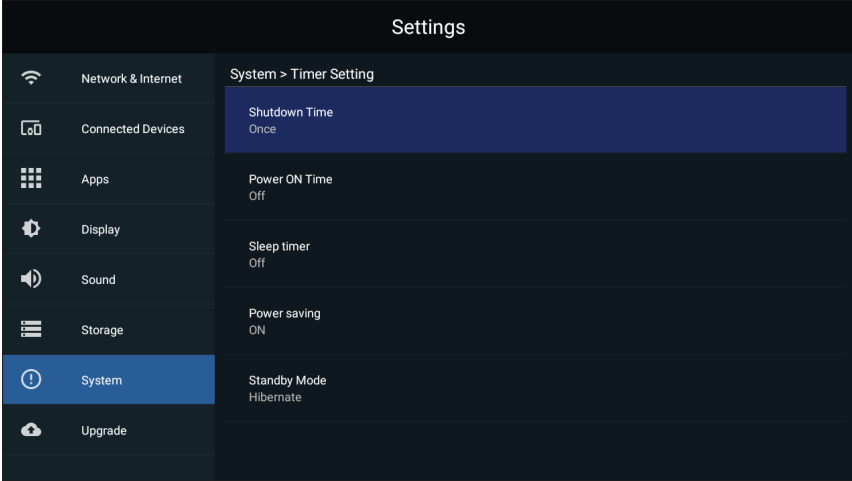
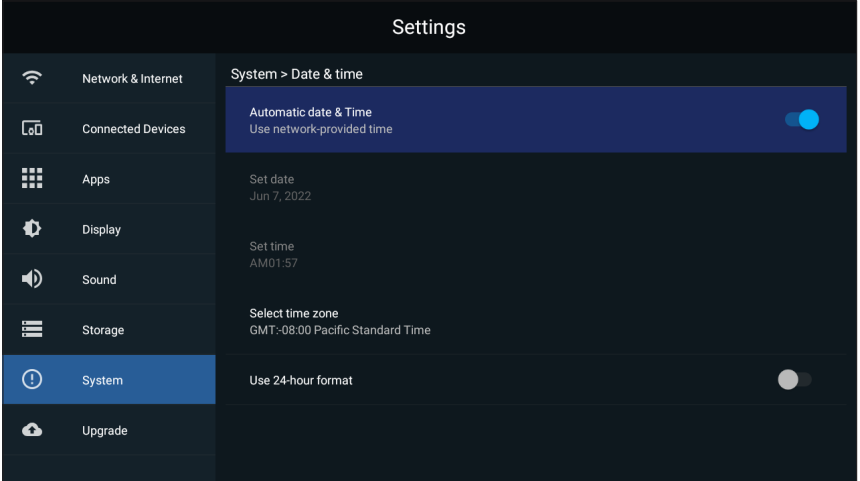
Sub-menu	Description
<p>Timer Setting</p>	 <p><u>Shutdown Time Repeat</u> Select the time and frequency for shutting down the display.</p> <p><u>Power ON Time Repeat</u> Select the time and frequency for powering ON the display.</p> <p><u>Sleep Timer</u> Set the amount of time before entering sleep mode.</p> <p><u>Power Saving</u> Select when to enable power saving mode.</p> <p><u>Standby Mode</u> Choose between Hibernate and Sleep modes.</p>
<p>Date & Time</p>	 <p><u>Automatic Date & Time</u> Enable or disable automatic time adjustment.</p> <p><u>Select Time Zone</u> Choose your appropriate time zone.</p> <p><u>Use 24-hour Format</u> Enable or disable 24-hour time format.</p>

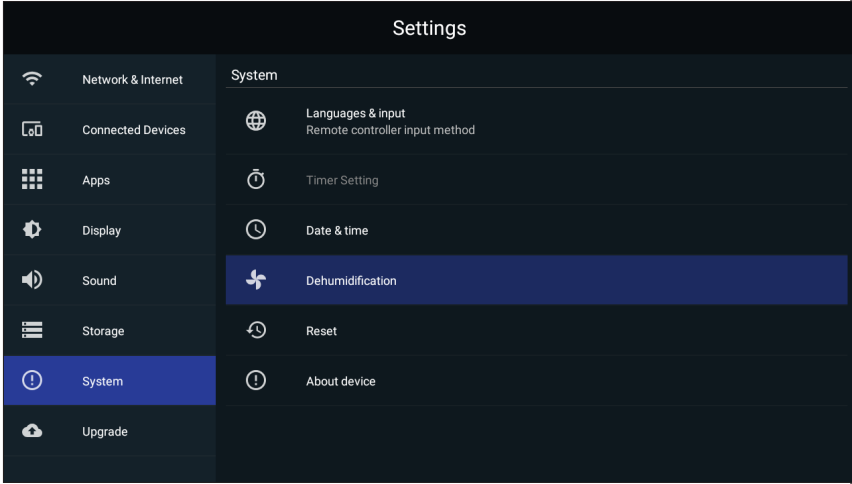
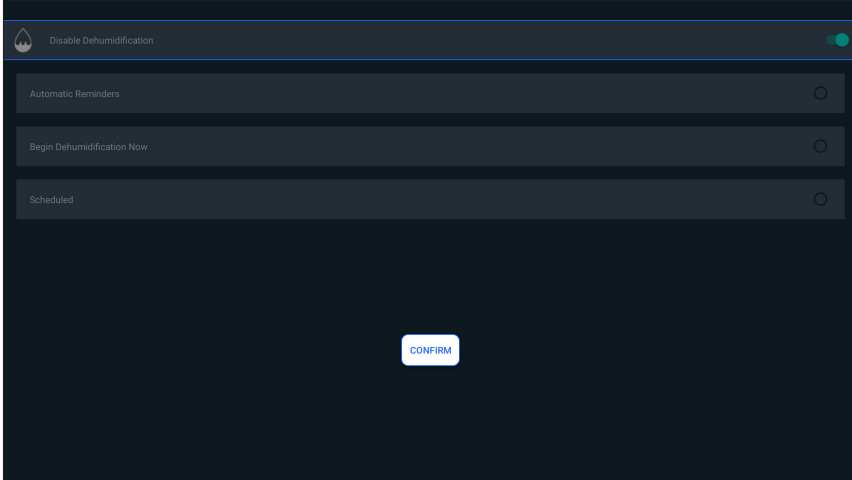
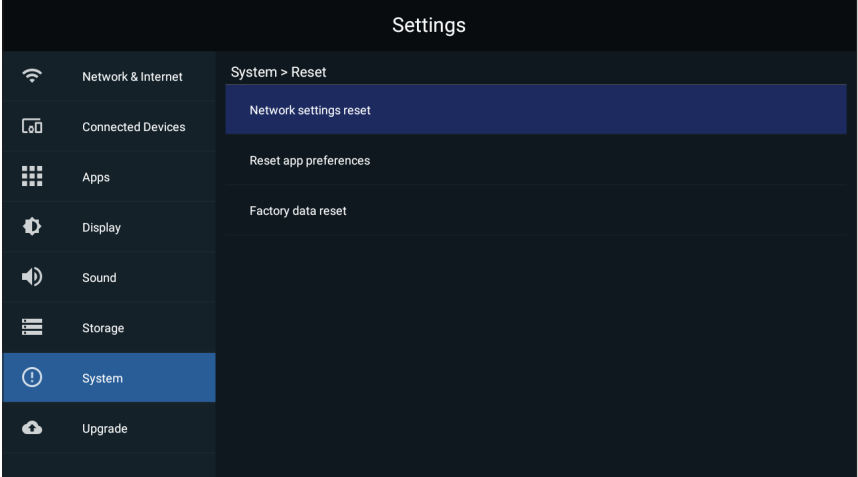
Sub-menu	Description
<p style="text-align: center;">Dehumidification</p>	<p>Start and adjust dehumidification settings.</p>  
<p style="text-align: center;">Reset</p>	 <p><u>Network Settings Reset</u> Reset current network settings.</p> <p><u>Reset App Preferences</u> Reset current app preferences.</p> <p><u>Factory Data Reset</u> Restore the display to default factory settings.</p>

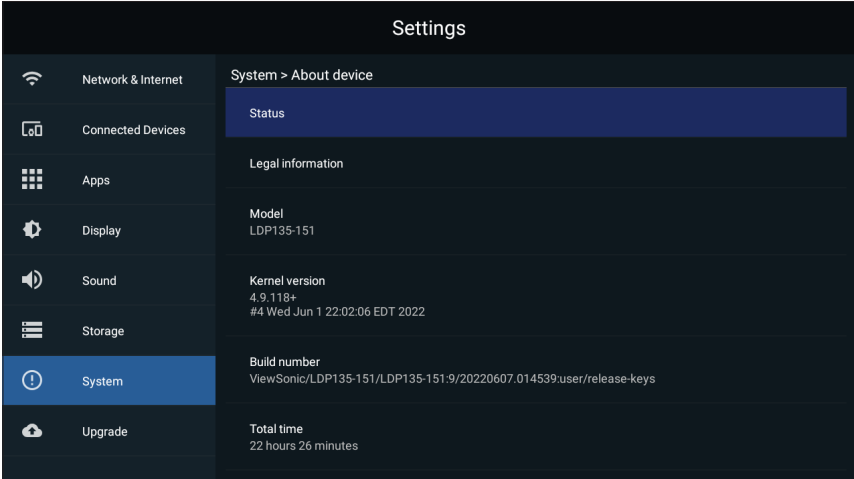
Sub-menu	Description
<p style="text-align: center;">About Device</p>	<p>View information about the display.</p> 

Upgrade

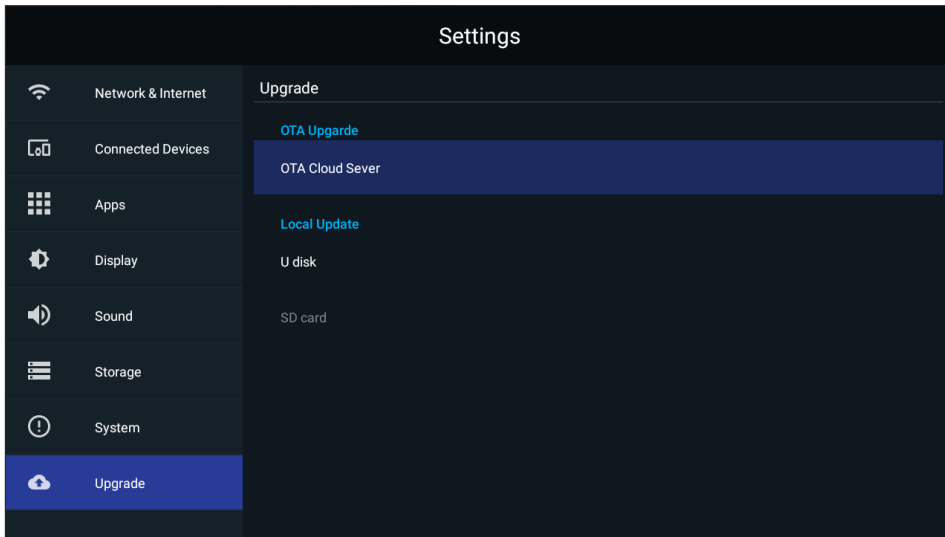

Sub-menu	Description
OTA Upgrade	<div data-bbox="571 792 1436 1276" data-label="Image"> </div> <p><u>Auto Update</u> Automatically apply updates as they become available or schedule the default update date and choose “Hibernate” as the Standby Mode, and the system will automatically update the schedule after shutdown.</p> <p><u>Manual Update</u> Check Update: The system will check for the latest FW automatically. If a new FW version is found, confirm the new FW is needed and then manually run the update. Local Update: Plug in a USB drive with the FW update in .zip format and run the .zip file to update the FW.</p>

On-Screen Display (OSD) Menu

Use the On-Screen Display (OSD) Menu to adjust settings.

NOTE: The OSD Menu is only available when there is an active input source, e.g. HDMI.

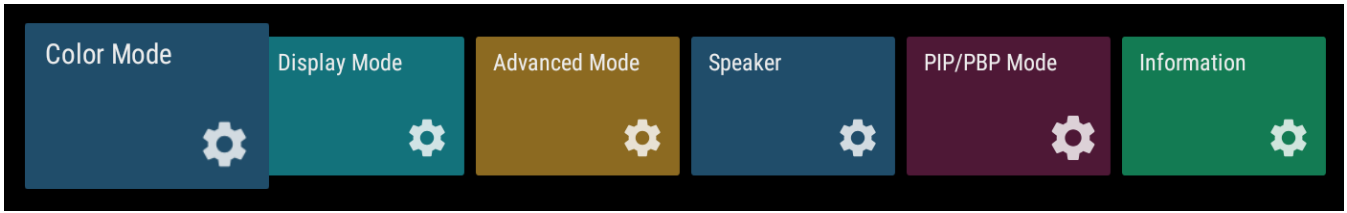

To open and operate the OSD Menu:

1. Press the **MENU** button on the remote control.
2. Press **▼/▲/◀/▶** on the remote control to select menu items or adjust values.
3. Press **OK** to confirm your selection.
4. Press the **RETURN** button to go back to the previous menu level.
5. Press the **MENU** button to exit the OSD Menu.

On-Screen Display (OSD) Menu Tree

Main Menu	Sub-menu	Menu Option
Color Mode	User	
	TV	
	Movie	
	Presentation	
Display Mode	Aspect Ratio	Auto
		4:3
		16:9
		Native
	Brightness	(-/+ , 0~100)
	Contrast	(-/+ , 0~100)
	Tint	(-/+ , -50~50)
	Saturation	(-/+ , 0~100)
	Sharpness	(-/+ , 0~20)
	Gamma	Dark
		Middle
		Bright
	Color Temp	User
		Standard
Cool		
Warm		
Reset		
Advanced Mode	HDR	Auto
		SDR
	EOTF	Dark
		Middle
		Bright
	HDMI Setting	Auto
		Full
		Limited

Main Menu	Sub-menu	Menu Option
Speaker	Audio Mode	User
		Standard
		Vivid
		Sports
		Movie
		Music
		News
		Auto
	EQ_120Hz	(-/+ , 0~100)
	EQ_500Hz	(-/+ , 0~100)
	EQ_1.5KHz	(-/+ , 0~100)
	EQ_5KHz	(-/+ , 0~100)
	EQ_10KHz	(-/+ , 0~100)
	Reset	
Audio Volume	(-/+ , -50~50)	
Mute	On	
	Off	
PIP/PBP Mode	Off	
	PIP	Sub Picture on Top Left
		Sub Picture on Top Right
		Sub Picture on Bottom Left
		Sub Picture on Bottom Right
	PBP	Windows x 2
		Windows x 3
		Windows x 4
Information	Source	
	Resolution	
	HDR	

Menu Options

Color Mode

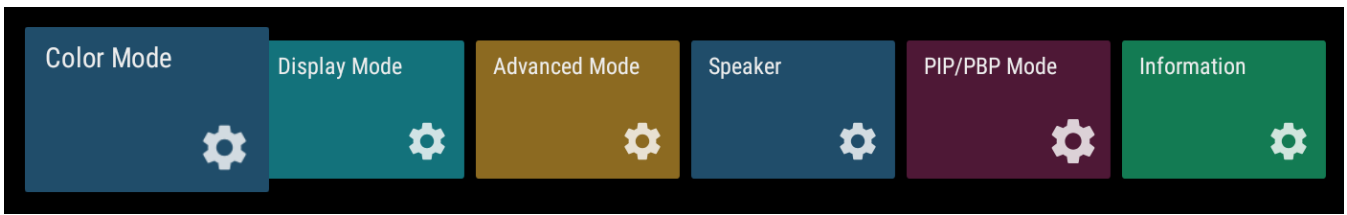

1. Press **MENU** on the remote control to display the OSD Menu.
2. Then press **OK** or use **▼/▲/◀/▶** on the remote control to select the **Color Mode** menu.
3. Press **▼/▲** to select the menu option. Then press **OK** to display its sub-menu, or press **◀/▶** to adjust/select the setting.

NOTE: Some sub-menu options may have another sub-menu layer.

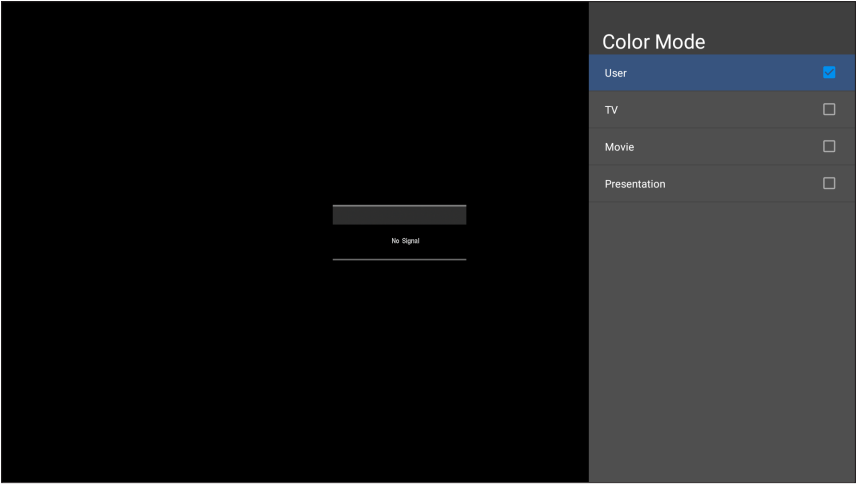
Menu Option	Description
Color Mode	 <p><u>User</u> Custom user setting.</p> <p><u>TV</u> Set the color temperature to 9300K.</p> <p><u>Movie</u> Set the color temperature to 6500K.</p> <p><u>Presentation</u> Set the color temperature to 7500K.</p>

Display Mode

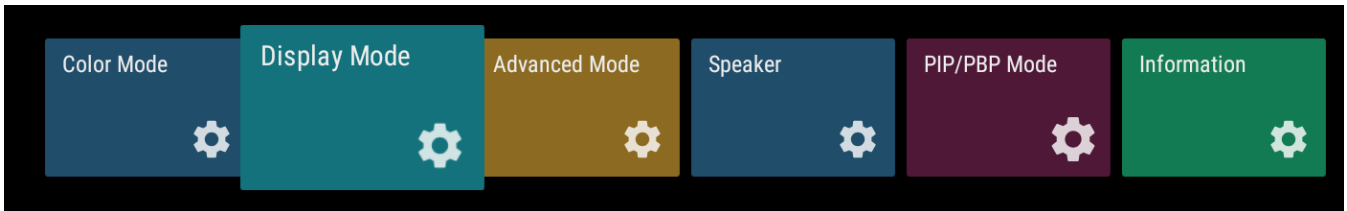

1. Press **MENU** on the remote control to display the OSD Menu.
2. Then press **OK** or use **▼/▲/◀/▶** on the remote control to select the **Display Mode** menu.
3. Press **▼/▲** to select the menu option. Then press **OK** to display its sub-menu, or press **◀/▶** to adjust/select the setting.

NOTE: Some sub-menu options may have another sub-menu layer.

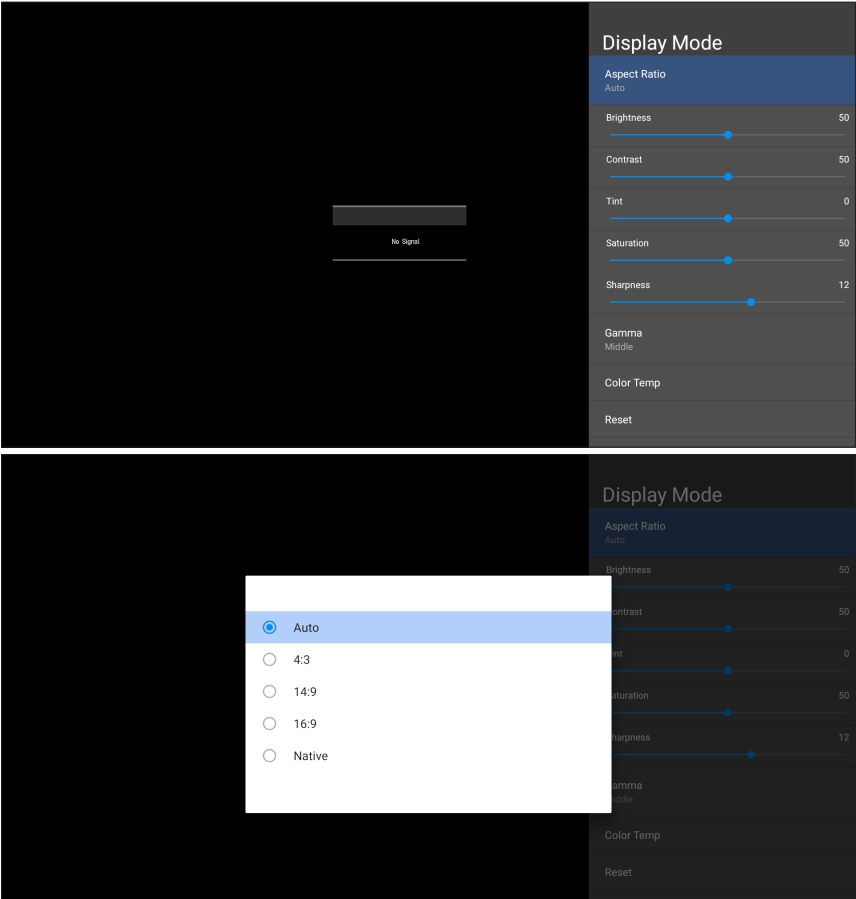
Menu Option	Description
<p>Aspect Ratio</p>	<p>The Aspect Ratio is the ratio of the image width to the image height.</p>  <p><u>Auto</u> Scales an image proportionally to fit the projector's native resolution in its horizontal width. This is suitable for the incoming image which is neither 4:3 nor 16:9 and you want to make the most use of the screen without altering the image's aspect ratio.</p> <p><u>4:3</u> Scales an image so that it is displayed in the center of the screen with a 4:3 aspect ratio. This is most suitable for 4:3 images like computer monitors, standard definition TV, and 4:3 aspect DVD movies, as it displays them without aspect alteration.</p>

Menu Option	Description
Aspect Ratio	<p><u>16:9</u> Scales an image so that it is displayed in the center of the screen with a 16:9 aspect ratio. This is most suitable for images which are already in a 16:9 aspect, like high definition TV.</p> <p><u>Native</u> Default aspect ratio.</p>
Brightness	The higher the value, the brighter the image. Lower values will result in a darker image.
Contrast	Use this to set the peak white level after you have previously adjusted the Brightness setting to suit your selected input and viewing environment.
Tint	The higher the value, the more greenish the picture becomes. The lower the value, the more reddish the picture becomes.
Saturation	Refers to the amount of that color in a video picture. Lower settings produce less saturated colors; in fact, a setting of "0" removes that color from the image entirely. If the saturation is too high, that color will be overpowering and unrealistic.
Sharpness	A high value results in a sharper picture; a low value softens the picture.

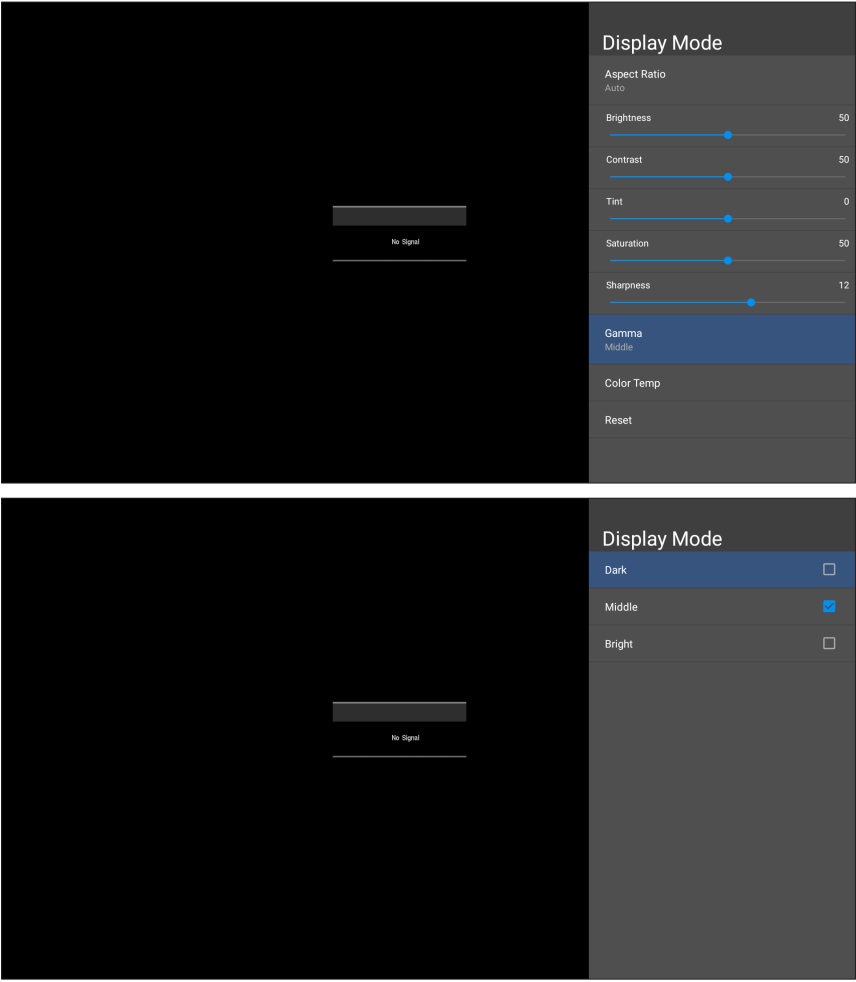
Menu Option	Description
<p style="text-align: center;">Gamma</p>	<p>Manually adjust the brightness level of the monitor's grayscale levels.</p>  <p>The image contains two screenshots of a monitor's settings menu. The top screenshot shows the 'Display Mode' menu with 'Gamma' selected. The 'Gamma' menu has 'Middle' selected. The bottom screenshot shows the 'Display Mode' menu with 'Middle' selected. Both screenshots show a 'No Signal' message on the screen.</p>

Menu Option	Description																								
<p data-bbox="233 674 408 707">Color Temp</p>	<p data-bbox="485 181 1161 215">Manually adjust the red, green, and blue values.</p> <div data-bbox="517 230 1377 1196"> <p>The image contains two screenshots of a TV's user interface. The top screenshot shows the 'Display Mode' menu with 'Color Temp' highlighted. The bottom screenshot shows the 'Color Temp' menu with sliders for Red Gain, Green Gain, and Blue Gain.</p> <table border="1"> <caption>Color Temp Menu Settings</caption> <thead> <tr> <th>Setting</th> <th>Value</th> </tr> </thead> <tbody> <tr> <td>Aspect Ratio</td> <td>Auto</td> </tr> <tr> <td>Brightness</td> <td>50</td> </tr> <tr> <td>Contrast</td> <td>50</td> </tr> <tr> <td>Tint</td> <td>0</td> </tr> <tr> <td>Saturation</td> <td>50</td> </tr> <tr> <td>Sharpness</td> <td>12</td> </tr> <tr> <td>Gamma</td> <td>Middle</td> </tr> <tr> <td>Color Temp</td> <td>User</td> </tr> <tr> <td>Red Gain</td> <td>0</td> </tr> <tr> <td>Green Gain</td> <td>0</td> </tr> <tr> <td>Blue Gain</td> <td>0</td> </tr> </tbody> </table> </div>	Setting	Value	Aspect Ratio	Auto	Brightness	50	Contrast	50	Tint	0	Saturation	50	Sharpness	12	Gamma	Middle	Color Temp	User	Red Gain	0	Green Gain	0	Blue Gain	0
Setting	Value																								
Aspect Ratio	Auto																								
Brightness	50																								
Contrast	50																								
Tint	0																								
Saturation	50																								
Sharpness	12																								
Gamma	Middle																								
Color Temp	User																								
Red Gain	0																								
Green Gain	0																								
Blue Gain	0																								

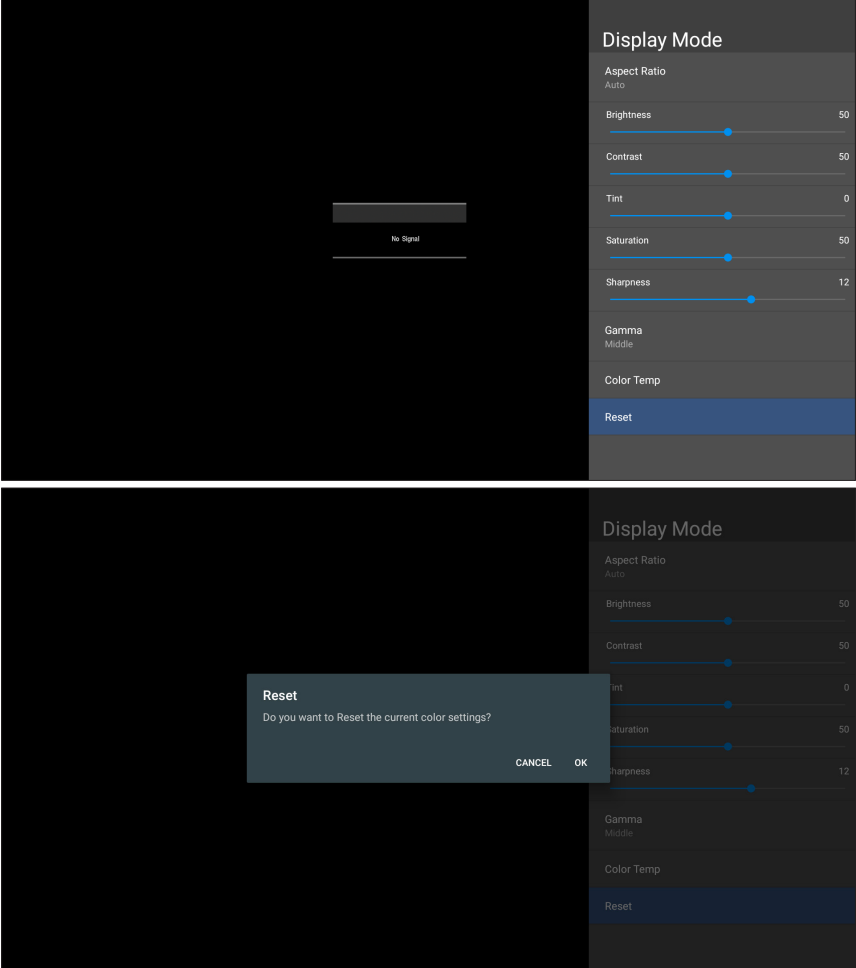
Menu Option	Description
<p style="text-align: center; font-size: 24pt; font-weight: bold;">Reset</p>	<p>Return the Display Mode settings to their default values.</p>  <p>The image contains two screenshots of a TV's 'Display Mode' menu. The top screenshot shows the menu with various settings like Aspect Ratio (Auto), Brightness (50), Contrast (50), Tint (0), Saturation (50), Sharpness (12), Gamma (Middle), and Color Temp. The 'Reset' option is highlighted at the bottom. The bottom screenshot shows the same menu with a confirmation dialog box overlaid, asking 'Do you want to Reset the current color settings?' with 'CANCEL' and 'OK' buttons.</p>

Advanced Mode

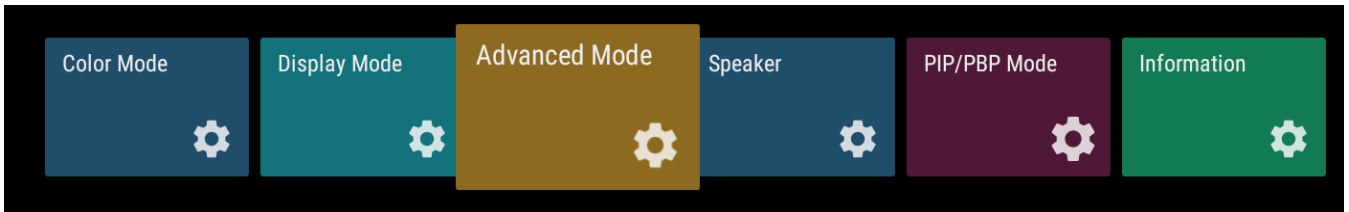

1. Press **MENU** on the remote control to display the OSD Menu.
2. Then press **OK** or use **▼/▲/◀/▶** on the remote control to select the **Advanced Mode** menu.
3. Press **▼/▲** to select the menu option. Then press **OK** to display its sub-menu, or press **◀/▶** to adjust/select the setting.

NOTE: Some sub-menu options may have another sub-menu layer.

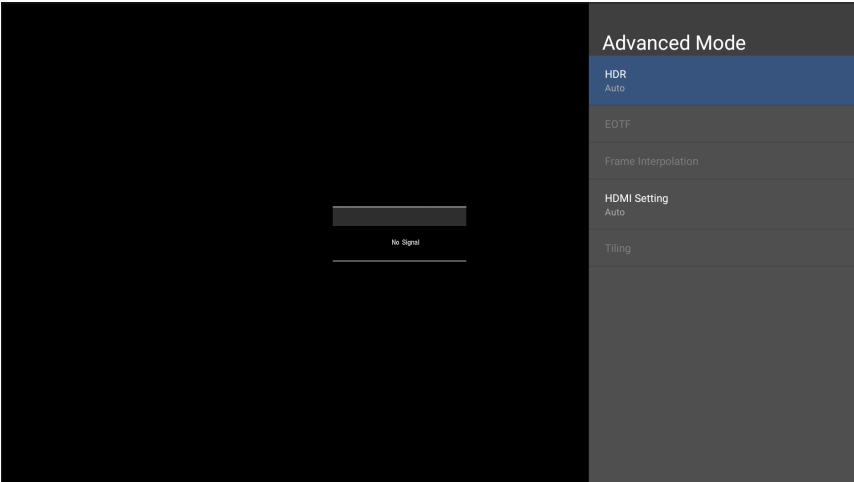
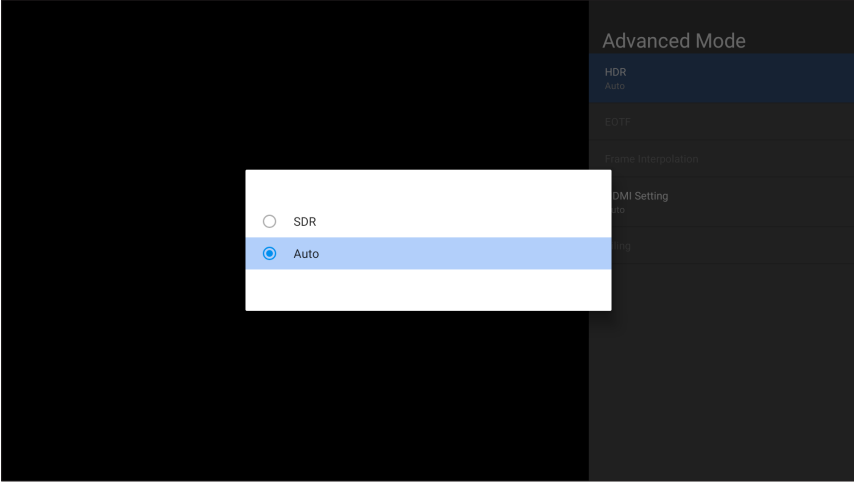
Menu Option	Description
<p style="text-align: center;">HDR</p>	<div style="display: flex; flex-direction: column; align-items: center;">   </div> <p><u>SDR</u> Enable Standard Dynamic Range.</p> <p><u>Auto</u> Automatically adjust to the input source.</p>

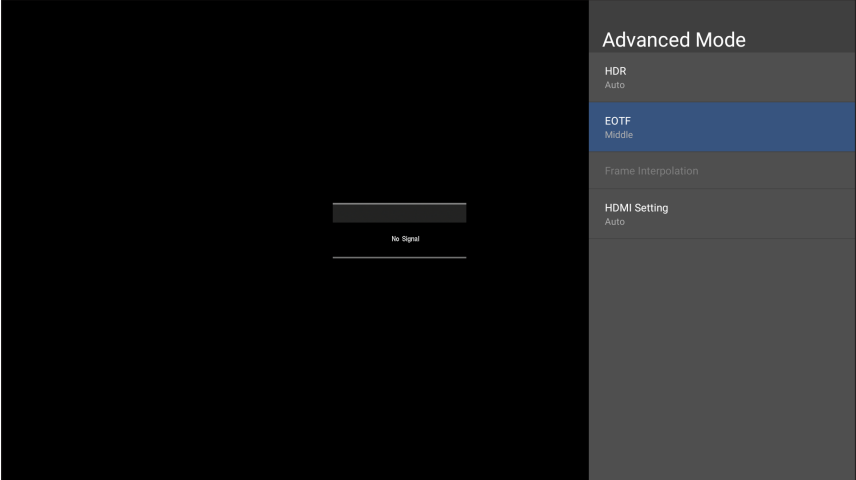
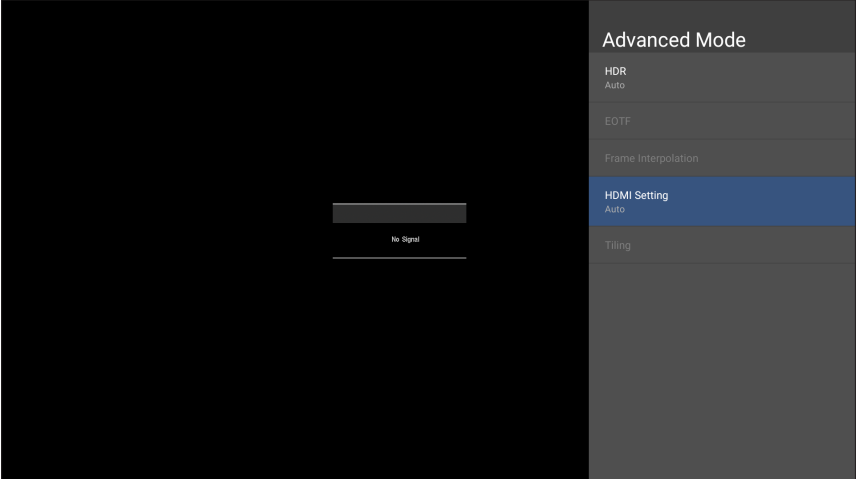
Menu Option	Description
<p style="text-align: center;">EOTF</p>	<p>Automatically adjusts the brightness levels of your image according to the input source. You can also manually select a brightness level to display better picture quality.</p>  <p>The screenshot shows the TV's Advanced Mode menu. The 'EOTF Mode' option is highlighted in blue and set to 'Middle'. Other visible options include HDR (Auto), Frame Interpolation, and HDMI Setting (Auto). The background of the menu is black with a 'No Signal' indicator in the center.</p>
<p style="text-align: center;">HDMI Setting</p>	 <p>The screenshot shows the TV's Advanced Mode menu. The 'HDMI Setting' option is highlighted in blue and set to 'Auto'. Other visible options include HDR (Auto), EOTF, Frame Interpolation, and Tiling. The background of the menu is black with a 'No Signal' indicator in the center.</p> <p><u>Auto</u> Sets the display to detect the range of the input signal automatically.</p> <p><u>Full</u> Sets the color range from 0~255.</p> <p><u>Limited</u> Sets the color range from 15~255.</p>

Speaker

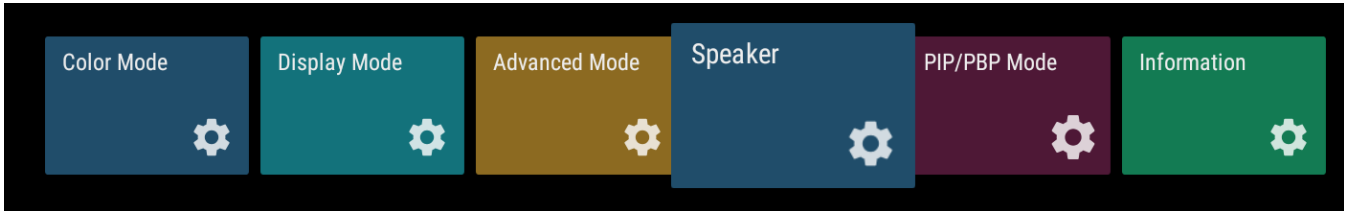

1. Press **MENU** on the remote control to display the OSD Menu.
2. Then press **OK** or use **▼/▲/◀/▶** on the remote control to select the **Speaker** menu.
3. Press **▼/▲** to select the menu option. Then press **OK** to display its sub-menu, or press **◀/▶** to adjust/select the setting.

NOTE: Some sub-menu options may have another sub-menu layer.

Menu Option	Description
<p>Audio Mode</p>	<div data-bbox="517 824 1378 1303" data-label="Image"> A screenshot of the TV's OSD menu. The 'Speaker' menu is open, showing 'Audio Mode' with three options: 'User', 'Music', and 'Movie'. Below these are frequency sliders for 120Hz, 500Hz, 1.5KHz, 5KHz, and 10KHz, each set to 0. There is also a 'Reset' button, an 'Audio Volume' slider set to 12, and a 'Mute' toggle switch. </div> <p><u>Music</u> Vibrant treble and stronger bass.</p> <p><u>Movie</u> Enhance the sense of space.</p> <p><u>User</u> Customize the audio equalizer.</p>

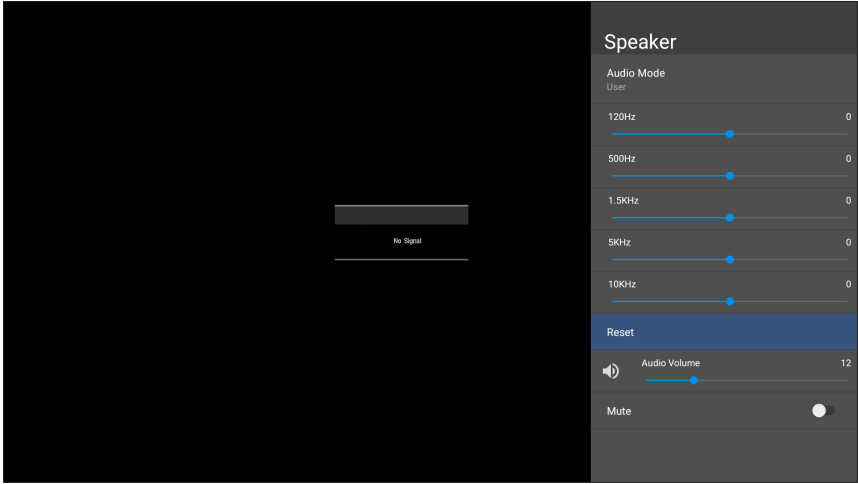
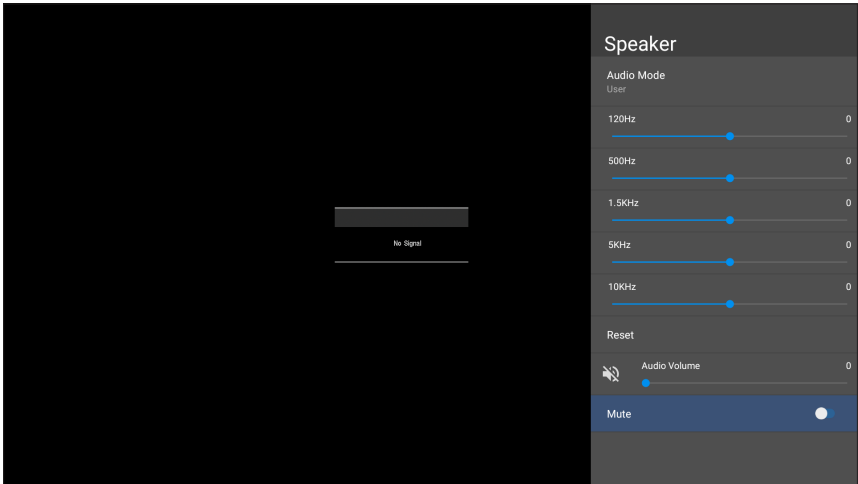
Menu Option	Description
<p style="text-align: center;">Reset</p>	<p>Return the Speaker settings to their default values.</p>  <p>The screenshot shows the 'Speaker' settings menu. At the top, it says 'Speaker' and 'Audio Mode: User'. Below are five frequency sliders: 120Hz, 500Hz, 1.5KHz, 5KHz, and 10KHz, all set to 0. The 'Reset' button is highlighted in blue. Below it is the 'Audio Volume' slider set to 12, and the 'Mute' toggle is turned off.</p>
<p>Audio Volume</p>	<p>Adjust the volume level.</p>
<p style="text-align: center;">Mute</p>	<p>Toggle On to turn off the speaker.</p>  <p>The screenshot shows the 'Speaker' settings menu. The 'Mute' toggle is highlighted in blue and turned on. The 'Audio Volume' slider is set to 0. The 'Reset' button is visible above it. The frequency sliders remain at 0.</p>

PIP/PBP Mode

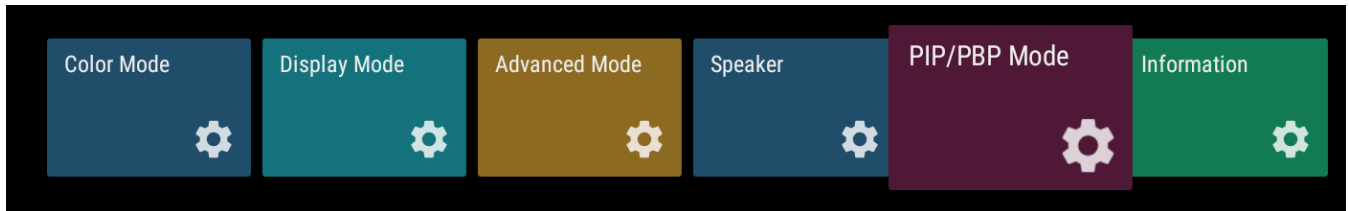

1. Press **MENU** on the remote control to display the OSD Menu.
2. Then press **OK** or use **▼/▲/◀/▶** on the remote control to select the **PIP/PBP Mode** menu.
3. Press **▼/▲** to select the menu option. Then press **OK** to display its sub-menu, or press **◀/▶** to adjust/select the setting.

NOTE: Some sub-menu options may have another sub-menu layer.

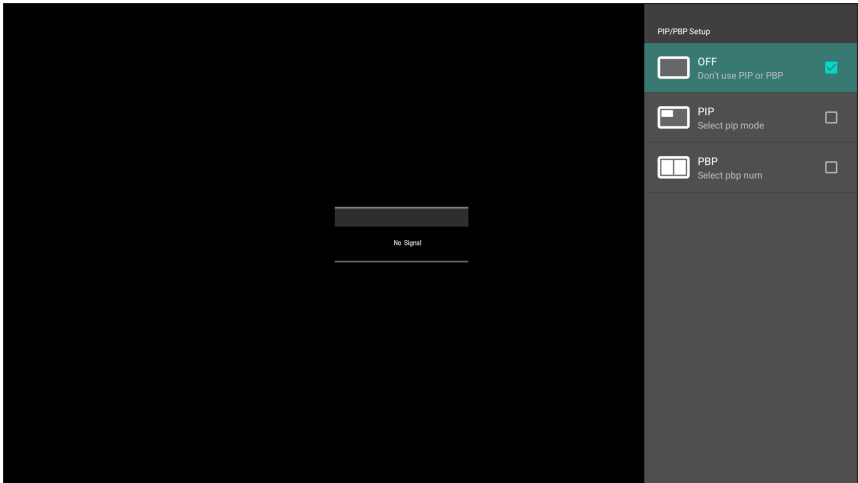
Menu Option	Description
<p>PIP/PBP Setup</p>	 <p>The screenshot shows the 'PIP/PBP Setup' menu with three options: 'OFF' (checked), 'PIP' (unchecked), and 'PBP' (unchecked). The 'OFF' option is highlighted in green.</p> <p><u>Off</u> Disable the PIP/PBP feature.</p>

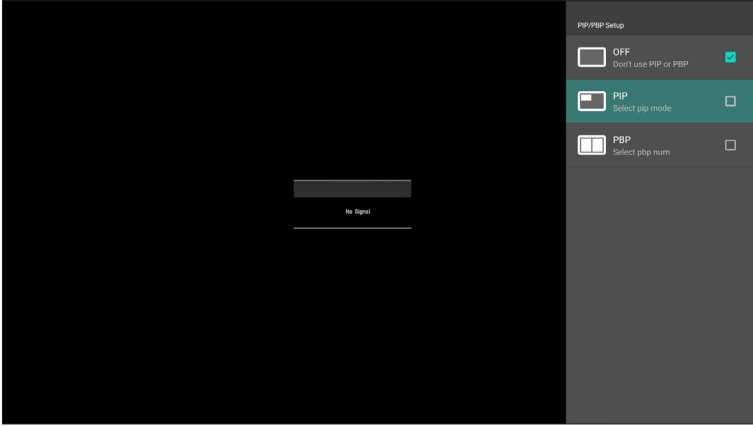
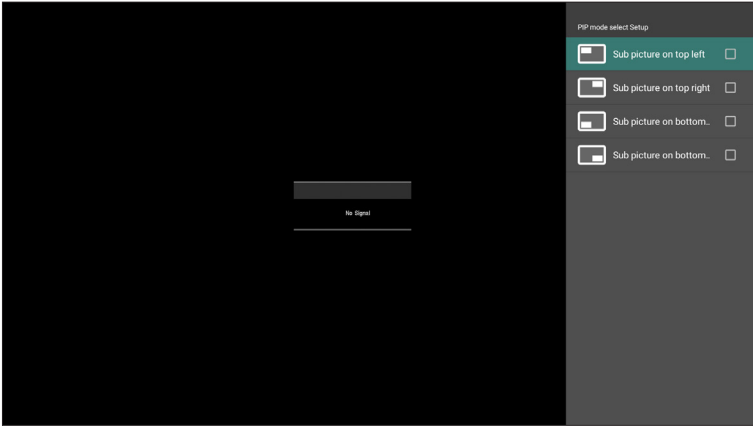
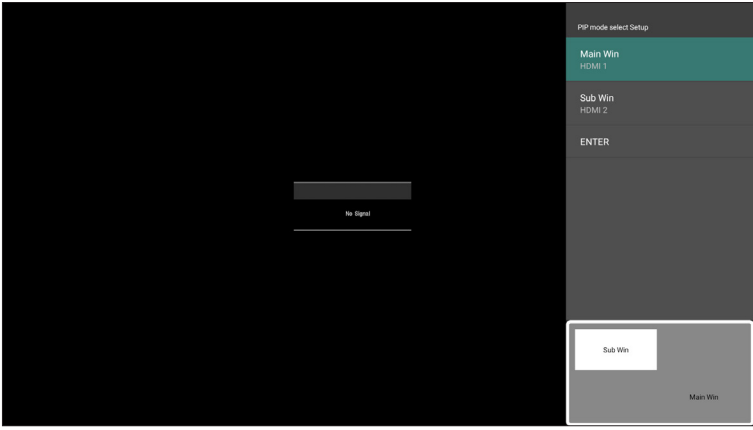
Menu Option	Description
<p>PIP/PBP Setup</p>	<p><u>PIP</u> Split the screen into two parts, a main window and an inset window. User can specify the input source for each screen.</p>
	 <p>The screenshot shows the 'PIP/PBP Setup' menu. The main display area is black with a 'No Signal' indicator. The menu options are: 'OFF Don't use PIP or PBP' (checked), 'PIP Select pip mode', and 'PBP select pbp num'.</p>
	 <p>The screenshot shows the 'PIP mode select Setup' menu. The main display area is black with a 'No Signal' indicator. The menu options are: 'Sub picture on top left', 'Sub picture on top right', 'Sub picture on bottom...', and 'Sub picture on bottom...'.</p>
	 <p>The screenshot shows the 'PIP mode select Setup' menu with a preview window. The main display area is black with a 'No Signal' indicator. The menu options are: 'Main Win HDMI 1', 'Sub Win HDMI 2', and 'ENTER'. A preview window at the bottom right shows a 'Sub Win' inset on a 'Main Win'.</p>

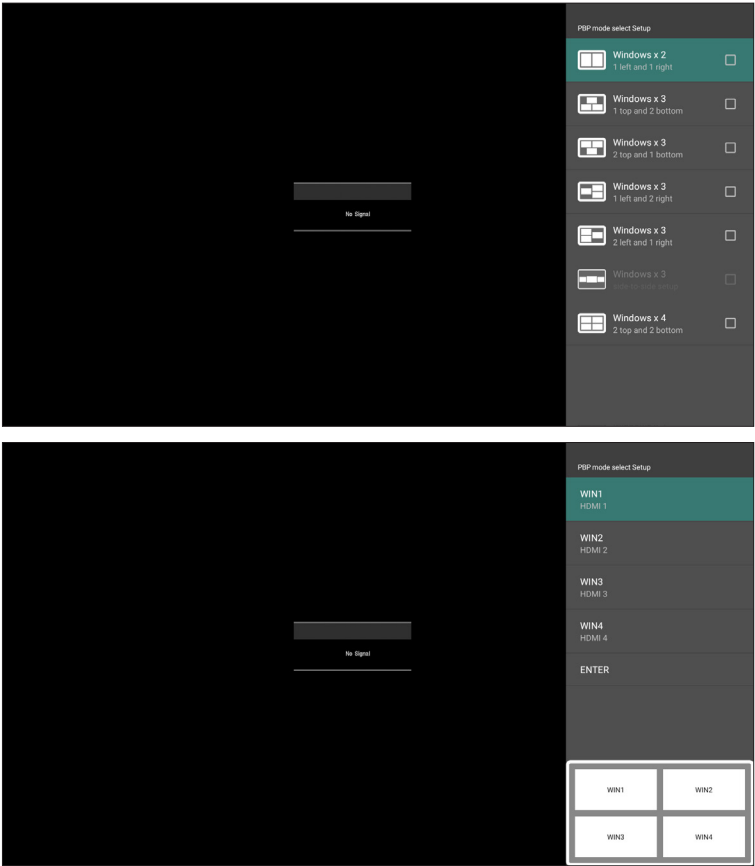
Menu Option	Description
<p style="text-align: center;">PIP/PBP Setup</p>	<p><u>PBP</u> Display up to four (4) windows on screen at the same time.</p> 

Information

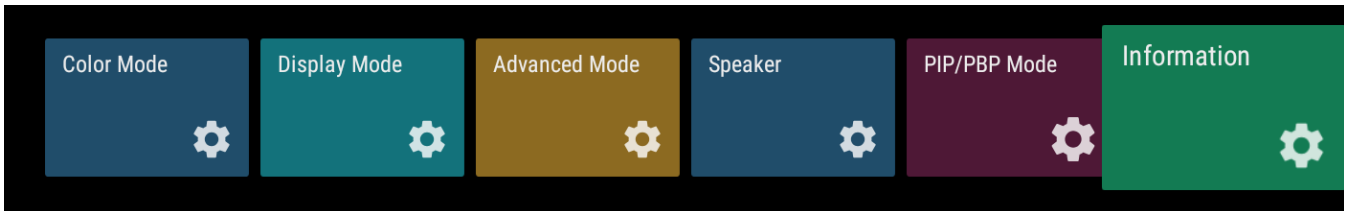

1. Press **MENU** on the remote control to display the OSD Menu.
2. Then press **OK** or use **▼/▲/◀/▶** on the remote control to select the **Information** menu.
3. Press **▼/▲** to select the menu option. Then press **OK** to display its sub-menu.

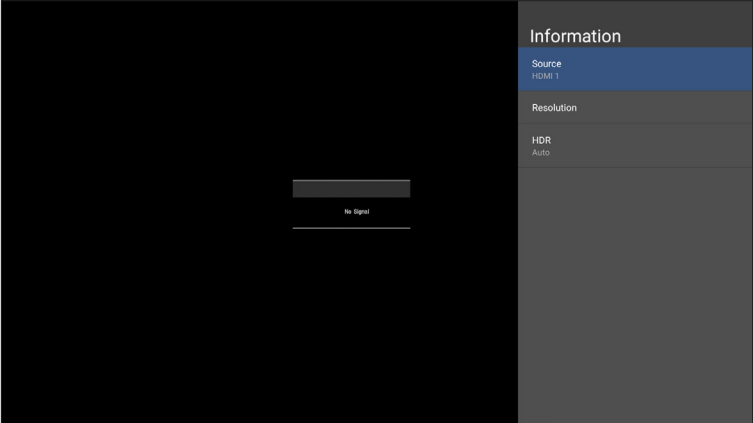
Menu Option	Description
Information	View Input Source, Resolution, and HDR information. 

Embedded Applications

ViewBoard Cast

Working with ViewBoard® Cast software, the vCastReceiver app, will allow the LED display to receive vCastSender screen sharing (Windows/Mac/Chrome) and mobile (iOS/Android) users' screens, photos, videos, annotations, and camera(s).

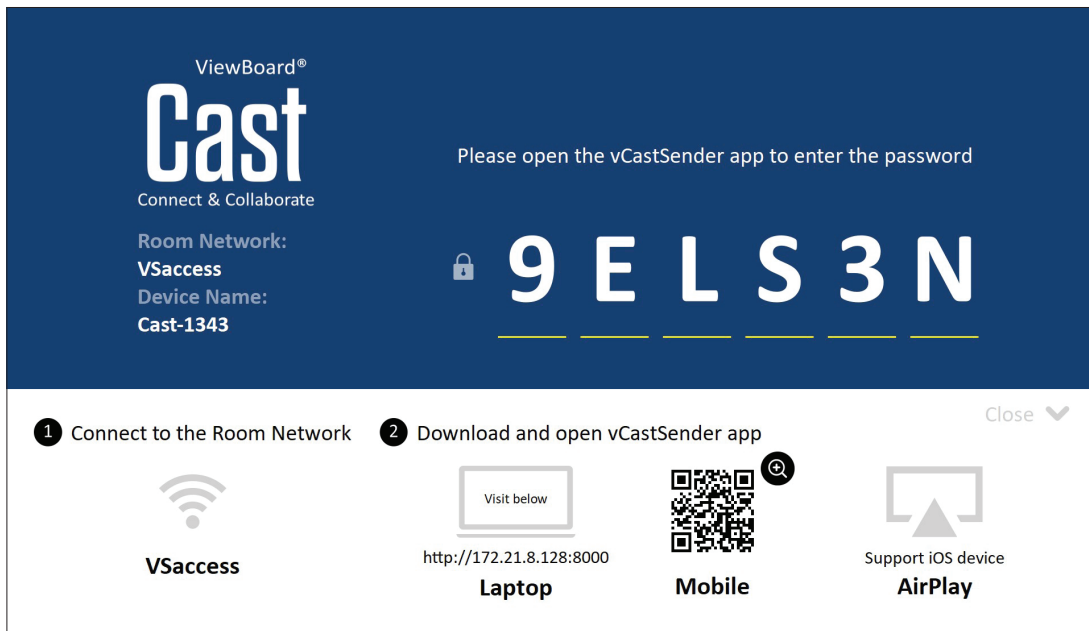

Network Information

- ViewBoard® Cast software, laptops, and mobile devices can be connected to the same subnet and across the subnet as long as it can communicate between the two.
- Connected devices will show up under “Device List” on the same subnet connection.
- If the device does not show up under “Device List”, users will need to key-in the on-screen PIN-code.

ViewBoard Cast is a wireless peer to peer data communication, therefore the following port settings are required:

Ports:

- CP: 56789, 25123, 8121, and 8000
- UDP: 48689 and 25123

Port and DNS activation:

- Port: 8001
- DNS: h1.ee-share.com

Cast Sender from Windows-based Devices, Macbook, and Chrome devices.

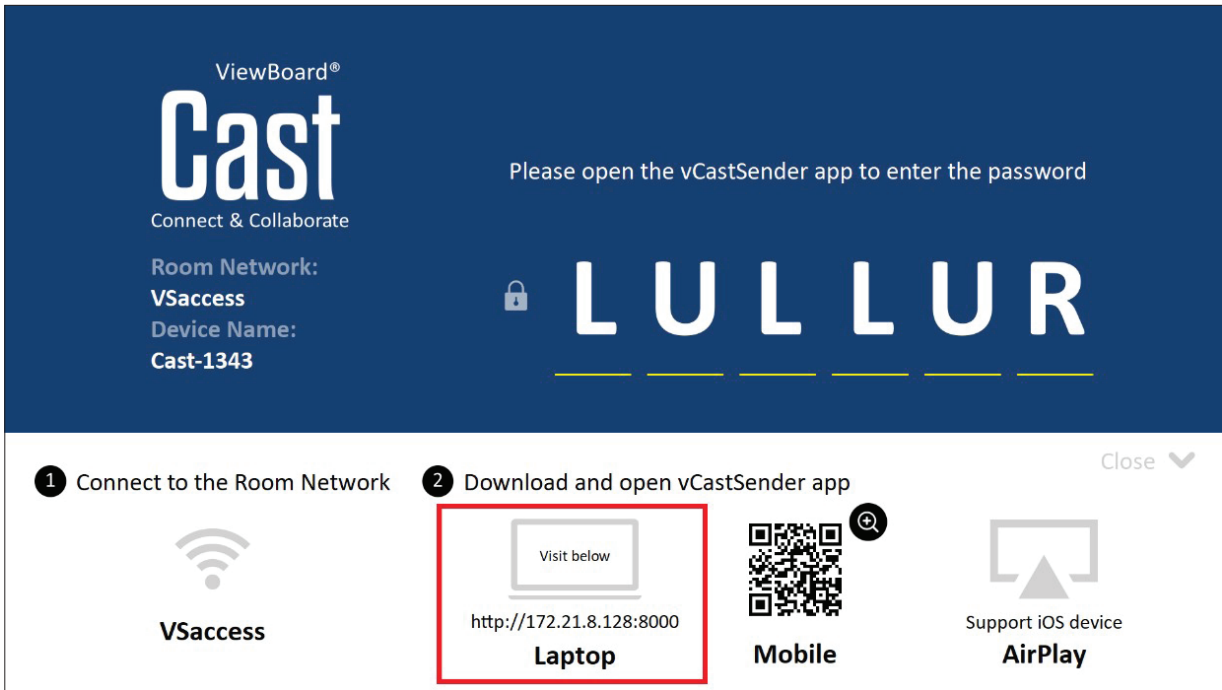

Mac, Windows, Chrome Devices:

1. Make sure your device is connected to the same network as the display.
2. Open a web browser and enter the address that is shown on the display to download the application.
3. Launch the application and click the connect icon next to the Device Name.

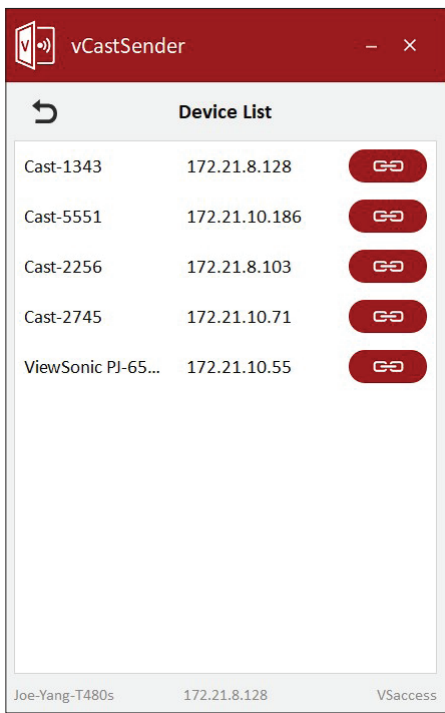

NOTE: If the device is not listed, click **Connect with PIN-Code** and input the pin-code displayed on the display.

Cast Sender from Mobile Devices: iOS-based (iPhone, iPad) and Android OS based phone/tablet.

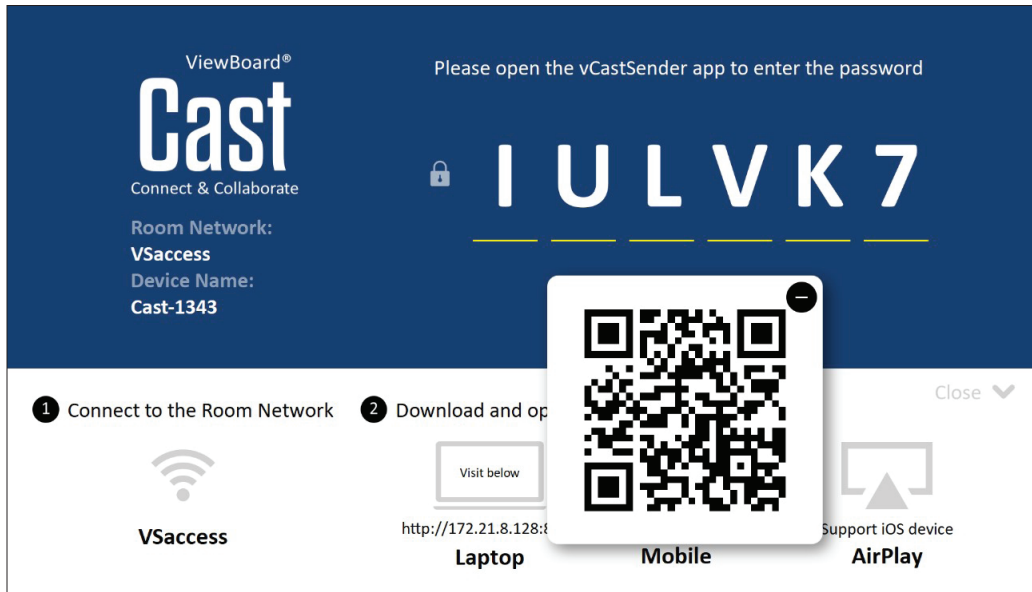

Android/iOS:

1. Make sure your device is connected to the same network as the display.
2. Scan the QR Code that is shown on the display to download the client application directly from the server, or download from the Google Play Store or the Apple Store.
3. Launch the application and select the correct Device Name and input the pin to connect. You can also directly input the pin-code displayed on the display to connect.





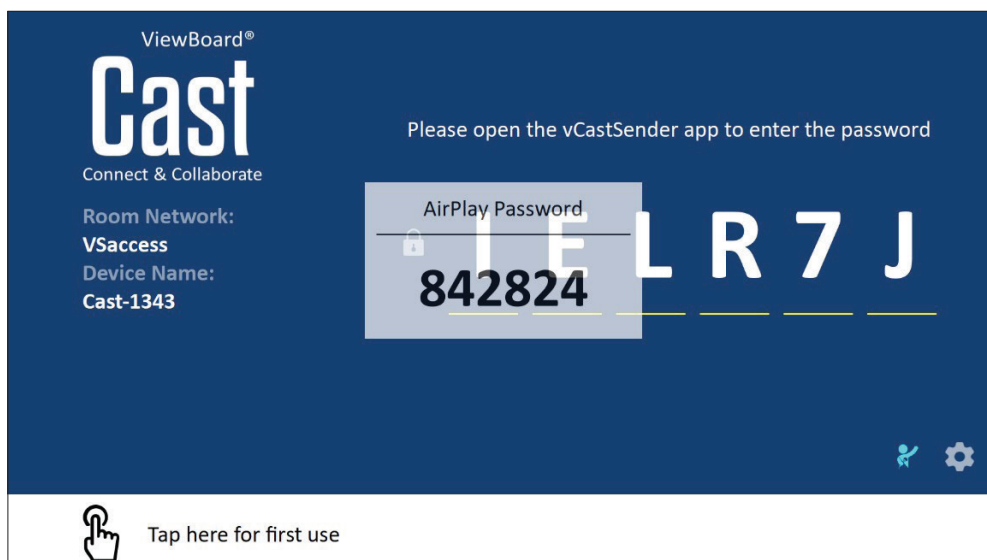

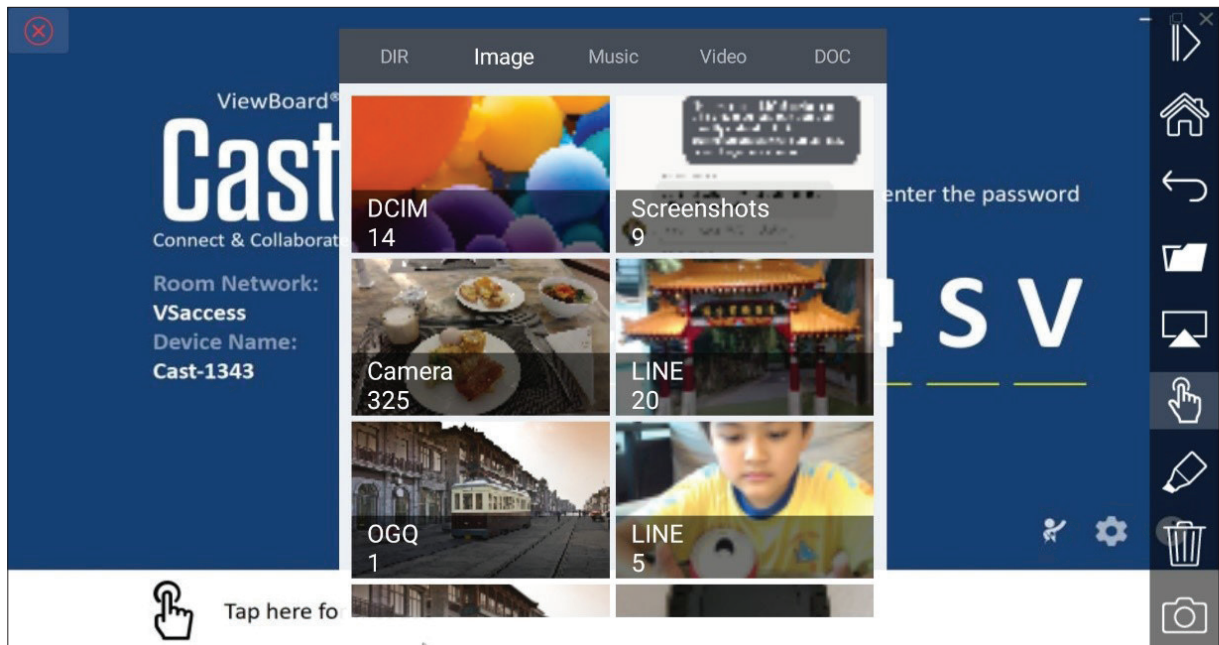

Apple AirPlay®:

1. Make sure your device is connected to the same network as the display.
2. Directly open AirPlay and select the Device Name to connect.
3. Another “AirPlay Password” will be generated on-screen for the connection.



Cast Out from a Mobile Device that Supports Annotation



Item	Description	
	Toggle	Hide or display the toolbar.
	Home	Return to the Home interface.
	Return	Return to the previous operation interface.
	Folder	View or open the mobile device's internal file.
	Screen sharing	Share the screen. NOTE: Android 5.0 and above supported.
	Touch	Change to touch mode.
	Pen	Make annotations, and change the color and thickness.
	Clear	Clear everything on the screen.
	Camera	Use the camera and send the image to the ViewBoard.

Browser

Web browser for surfing the Internet.

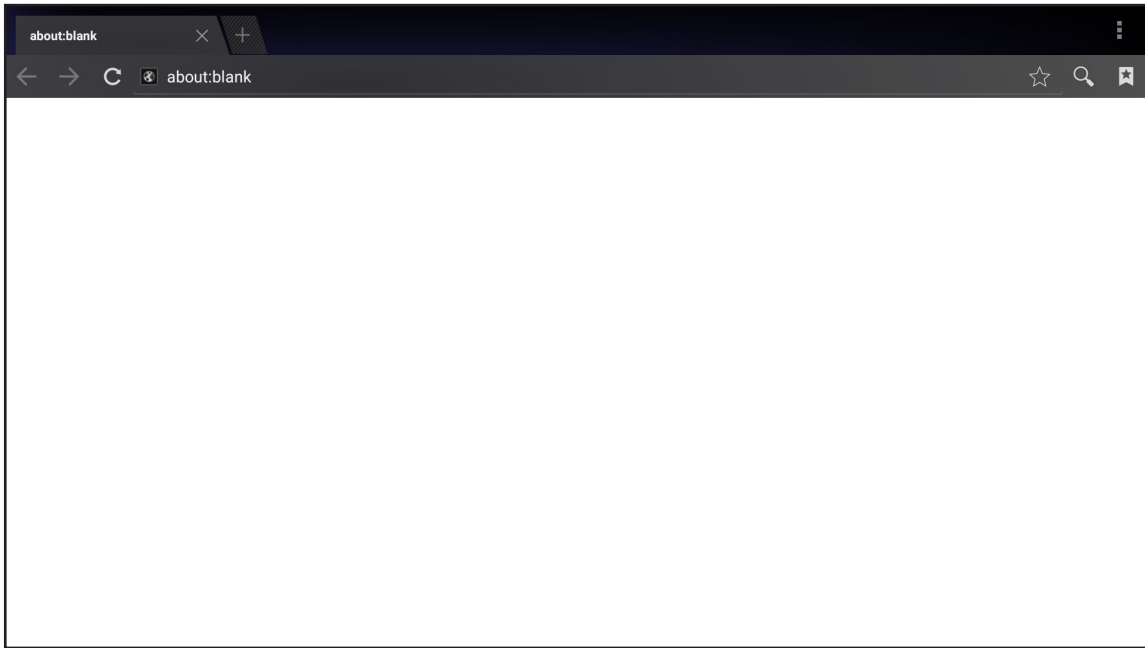

vSweeper

Remove unnecessary data and unwanted files.

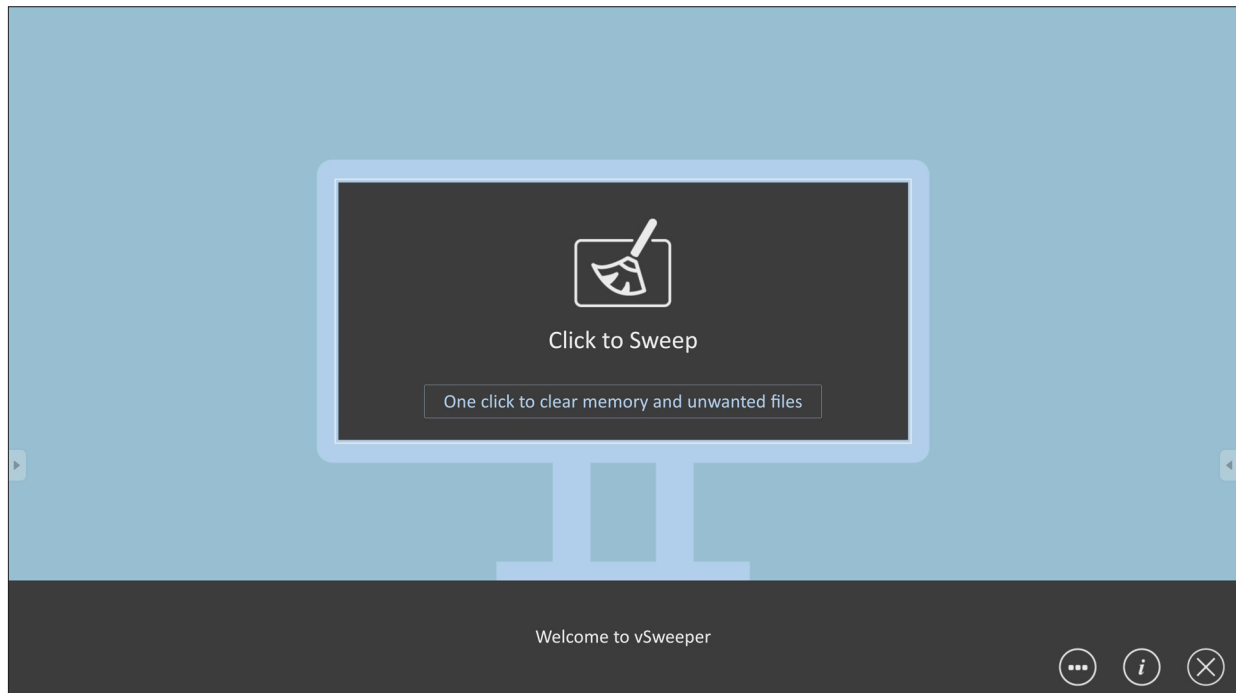

Advanced Settings can also be customized to the user's needs.

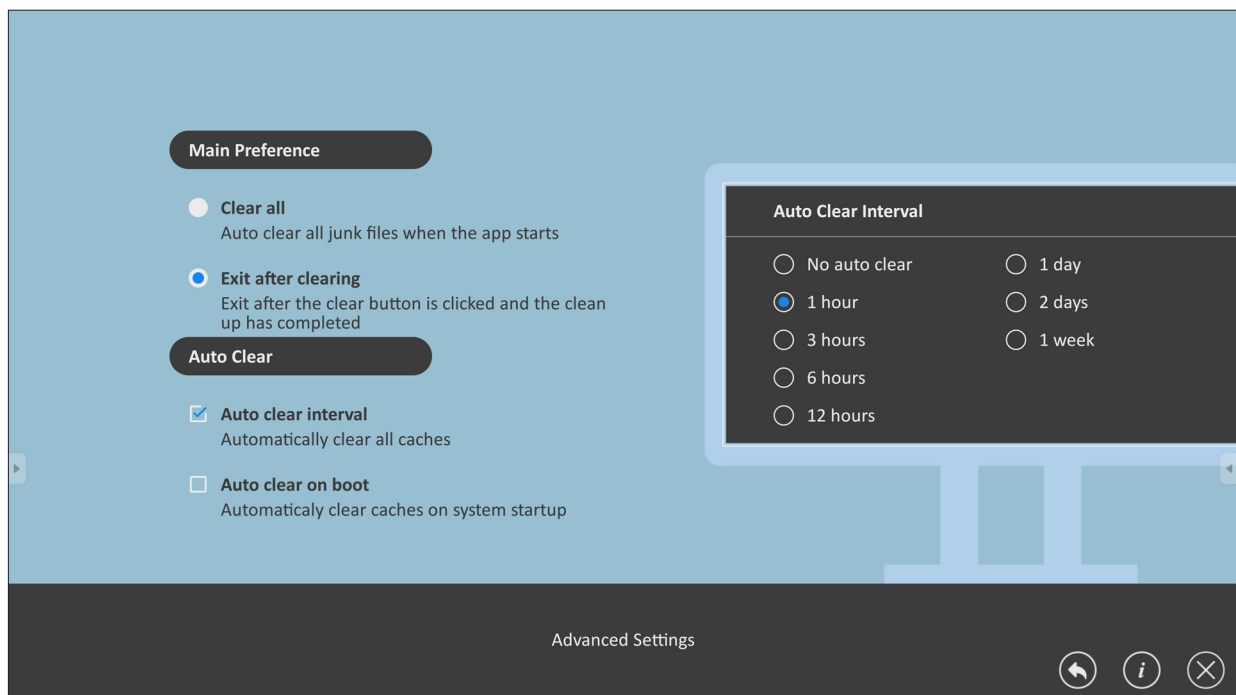

WPS Office

Create, edit, and view Documents, Memos, Presentations, and Spreadsheets.

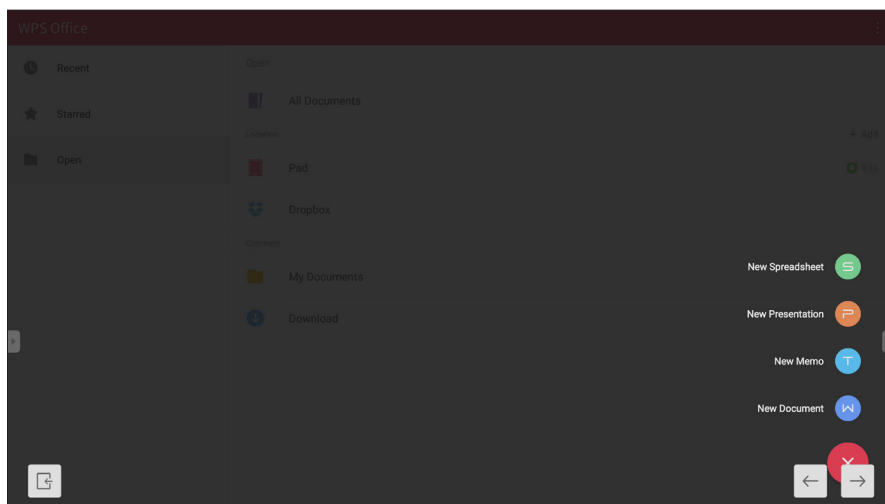
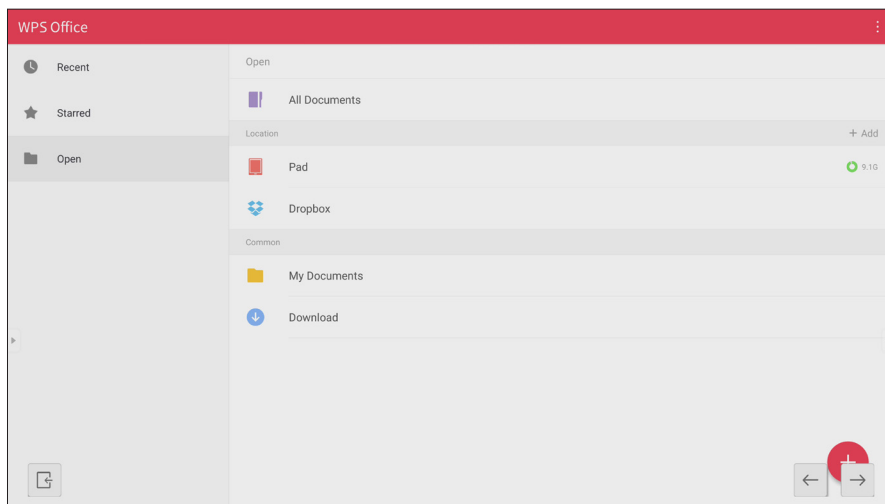

Appendix

Specifications

Item	Category	Specifications
Model		LDP135-151
LED Screen	Type	Direct View LED Display
	Size	135"
	Active Size	118.11" (H) x 66.44" (V) 3,000 mm (H) x 1,687.5 mm(V)
	Pitch Size	1.5625 mm
	Resolution	FHD, 1920 x 1080
	Refresh Frequency	4440Hz
	Contrast Ratio	6000:1 (Typical)
	Brightness	100-600 cd/m2 (8 levels of adjustments)
	LED Lifespan	100,000 hours
Input Signal		6 x HDMI (1920 x 1080 @ 60Hz, HDCP 2.2) 1 x LAN (RJ45) 3 x USB Type A (2.0) 1 x USB Type C
Output Signal		2 x HDMI (1080p @ 60Hz) 1 x Audio Out (3.5 mm) 3 x USB Type A (Power)[5V/1.5A]
Speaker Output		20W x 2 Harman-Kardon
RS-232		RS-232 Serial Control
Power	Voltage	100-120V/30A ~ 50/60Hz
		220-240V/15A ~ 50Hz (vary by country)
Operating Conditions	Temperature	32° F to 104° F (0° C to 40° C)
	Humidity	20%~80% non-condensing
	Altitude	≤ 6,562 ft (2,000 m)
Storage Conditions	Temperature	-4° F to 140° F (-20° C to 60° C)
	Humidity	10%~90% non-condensing
	Altitude	≤ 6,562 ft (2,000 m)
Physical Dimensions (W x H x D)	w/o Wall Mount	118 1/2" x 71 5/32" x 63/64" (3010 x 1807.5 x 25 mm)
	w/ Wall Mount	118 1/2" x 71 5/32" x 2 1/4" (3010 x 1807.5 x 57 mm)
Weight	Physical	265 lbs. (120 kg)
Power Consumption	On	2,030W (Normal) 2,900W (Max)
	Sleep	<0.5W
	Off	<0W

NOTE: Product specifications are subject to change without notice.

LED Display Stuck Pixel Definition

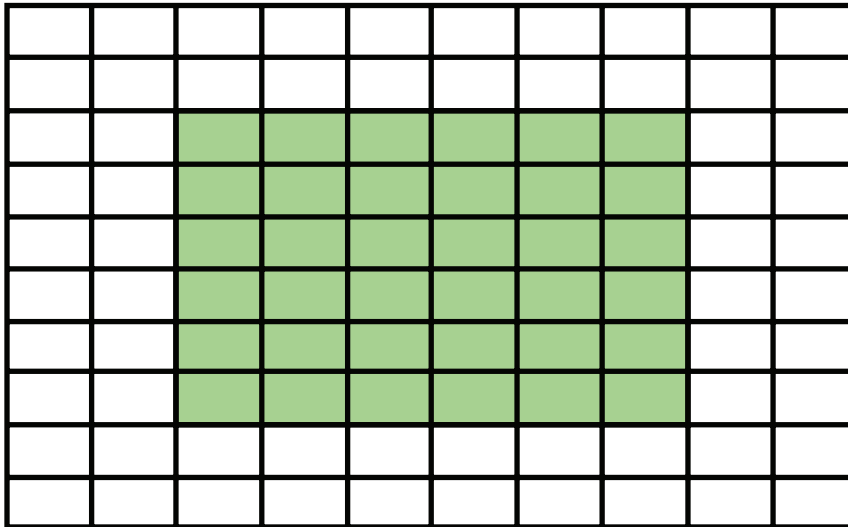

Item	Acceptance Criteria
Stuck Pixel (whole display)	≤ 60 stuck pixels
Stuck Pixel (as marked in green)	≤ 15 stuck pixels
Stuck Pixel (Single Module)	≤ 6 stuck pixels

Timing Chart

HDMI (PC)

Resolution	Refresh Rate (Hz)
640 x 480	60, 72, 75
720 x 400	70, 85
800 x 600	56, 60, 72, 75
832 x 624	75
1024 x 768	60, 70, 75
1152 x 864	60, 70, 75
1152 x 870	75
1280 x 720	60
1280 x 960	60
1280 x 1024	60, 75
1360 x 768	85
1440 x 900	60
1680 x 1050	60
1600 x 1200	60, 70, 75
1920 x 1080	60
1920 x 1200	60
3840 x 2160	30, 60

HDMI (Video)

Video	Resolution	Refresh Rate (Hz)
480i	720 x 480	60
	1440 x 480	60
576i	720 x 576	50
	1440 x 576	50
480p	720 x 480	60
576p	720 x 576	50
	1440 x 576	50
720p	1280 x 720	60
1080i	1920 x 1080	50, 60
1080p	1920 x 1080	24, 25, 30, 50, 60
2160p	3840 x 2160	30, 60

NOTE:

- The computer text quality is optimal in HD 1080 mode (1920 x 1080, 60Hz).
- Your computer display screen might appear different depending on the manufacturer and your operating system.
- Consult your computer's instructional manual on how to connect to an external display.
- If a vertical and horizontal frequency-select mode exists, select 60Hz (vertical) and 67.5KHz(horizontal). In some cases, abnormal signals (such as stripes) might appear on the screen when the computer power is turned off (or if the computer is disconnected). If this is the case, press the [INPUT SOURCE] button to enter the video mode and supply an active signal.
- The display timings conform to VESA and CTA standards.
- For 4:3 content, the screen will display them in the center of the screen and maintain a 4:3 aspect ratio.
- The optimal vertical frequency for each mode is 60Hz.

Supported Media Formats

Multimedia Codec Formats

Type	File Type	Codec	Ability
Photo	PNG		Max Resolution: 8000 × 8000 Min Resolution : 4 x 4
	JPEG/JPG		Max Resolution: 8000 × 8000 Min Resolution : 4 x 4 ¹
Video	.3gp	H.263	Max Resolution: 1920 x 1080 30 Audio: AMR_NB
		MPEG-4	Max Resolution: 1920 x 1080 30 Audio: AMR_NB
	.avi	MPEG-2/4	Max Resolution: 1920 x 1080 30 Audio: MPEG_Audio_Layer3
		MJPEG	Max Resolution: 1920 x 1080 30 Audio: MPEG_Audio_Layer3
	.flv	H.264	Max Resolution: 1920 x 1080 30 Audio: AAC 2.0
	.mkv	H.264	Max Resolution: 1920 x 1080 30 Audio: AAC 2.0
		H.265	Max Resolution: 1920 x 1080 30 Audio: AAC 2.0
	.mp4	H.264	Max Resolution: 3840 x 2160 30 Audio: MPEG_Audio_Layer3
		H.265	Max Resolution: 3840 x 2160 30 Audio: MPEG_Audio_Layer3
		MPEG-4	Max Resolution: 1920 x 1080 30 Audio: MPEG_Audio_Layer3
	.vob	MPEG-2	Max Resolution: 1920 x 1080 30 Audio: PCM
	.mpg/.mpeg	MPEG-2	Max Resolution: 1920 x 1080 30 Audio: MPEG_Audio_Layer3

1 Progressive support 4000 × 4000; baseline support 8000 x 8000.

Type	File Type	Codec	Ability
Audio	.aac	GAAC	Sample Rate: 8K~96KHz Bit Rate: 24K~576Kbps
	.ape	Monkey's Audio	Sample Rate: max 48KHz Bit Rate: max 1411Kbps
	.flac	FLAC	Sample Rate: max 192KHz Bit Rate: max 1411Kbps
	.m4a	ALAC	Sample Rate: 8K~96KHz Bit Rate: 24K~576Kbps
	.mp3	MPEG1/2 layer 3	Sample Rate: 8K~48KHz Bit Rate: 32K~320Kbps
	.ogg	Vorbis	Sample Rate: 8K~48KHz Bit Rate: max 256Kbps
	.wav	LPCM	Sample Rate: 8K~192KHz Bit Rate: max 320Kbps

Troubleshooting

Problem or Issue	Possible Solutions
Remote Control is not working	<ol style="list-style-type: none"> 1. Check whether something is obstructing the display's remote control receiver. 2. Check whether the battery polarities in the remote control are installed correctly. 3. Check whether the batteries need to be replaced.
The unit turns off unexpectedly	<ol style="list-style-type: none"> 1. Check whether Sleep mode is enabled. 2. Check if there is a power outage in your area. 3. Turn on the display, provide an active signal, and see if the problem is with the signal or external control system.
The power indicator is off, and there is no response	<ol style="list-style-type: none"> 1. Ensure the power cable is connected and not loose. 2. Check that the power outlet is functioning properly and meets the required electrical requirement.
The display does not recognize the USB storage device	<ol style="list-style-type: none"> 1. Ensure the drive is either formatted for FAT32 or NTFS. 2. If the USB storage device needs external power, connect its power adapter to an electrical outlet.

Video Not Working Properly

Problem or Issue	Possible Solutions
No picture/No sound	<ol style="list-style-type: none"> 1. Check the Power status. 2. Check the signal cable. 3. Use the remote control to ensure the input source setting is the same as the connected device.
Picture is unclear or cuts in and out	<ol style="list-style-type: none"> 1. Check the signal cable. 2. Check if other electronics or different signal types are interrupting the signal. 3. An optional active video cable or optional video extender is required for a long distance source.

Problem or Issue	Possible Solutions
Poor picture	<ol style="list-style-type: none"> 1. Adjust chroma and/or brightness settings in the menu. 2. Check the signal cable. 3. Use the display's native resolution for the source.

Audio Not Working Properly

Problem or Issue	Possible Solutions
No sound	<ol style="list-style-type: none"> 1. Press the Mute/Unmute button. 2. Adjust the volume. 3. Check the audio cable connection (if used). 4. If using a computer digital video with embedded audio, ensure the computer speakers are set to external speakers.
One speaker only	<ol style="list-style-type: none"> 1. Adjust the sound balance in the menu. 2. Check the left and right sound control panel settings of the computer or media player source. 3. Check the audio cable connection (if used). 4. Ensure the content has two audio channels and not mono.

Maintenance

General Precautions

- The LED lights used in the modules are susceptible to ESD (Electrostatic discharge). To prevent damage to the LED lights, do not touch them with bare hands or with conductive materials when handling.
- It is recommended to regularly inspect all installed components.
- Do not bring objects close to the ventilation holes of the display. Burns or personal injuries may occur if any body parts are brought too close.
- Be sure to power off and disconnect all cables before moving the display. Moving the display with its cables attached may damage the cables and thus cause fire or electric shock.
- Power off and disconnect the power plug from the wall outlet as a safety precaution before performing any type of cleaning or maintenance.

Initial Operation

- If a new screen has been stowed for less than three (3) months, it can be used at normal brightness during its first use.
- If a new screen has been stowed for more than three (3) months, the brightness should be set at 30% for its first use and allowed to operate for two (2) hours continuously. After two (2) hours of use, power off for 30 minutes. The new screen is now ready for normal brightness usage.

Front Panel Cleaning Instructions

- Use cool, compressed air to remove dust when the power is off. If the dust cannot be removed, the LED module should be replaced.
- Do not scratch and do not put pressure on the panel surface with fingers or any abrasive object.
- Do not use volatile substances such as sprays, solvents, or thinners.

Cabinet Cleaning Instructions

- Do not allow water or detergent to come into contact with the surface of the display. If water or moisture gets inside the unit, a system malfunction or electrical shock may occur.
- Do not scratch and do not put pressure on the cabinet with any abrasive objects of any kind.
- Do not use volatile substances such as sprays, solvents, or thinners on the cabinet.
- Do not place anything made from rubber or PVC near the cabinet for any extended periods of time.

Regular Use

- It is recommended to turn on the display at least once a month for more than eight (8) hours. During a wet and rainy season, it is recommended to turn on the display at least once a week.
- Avoid using full white, full red, full blue, or full green content for an extended period to avoid excessive power usage thus affecting the LED lifespan.

Vacuum Suction Tool

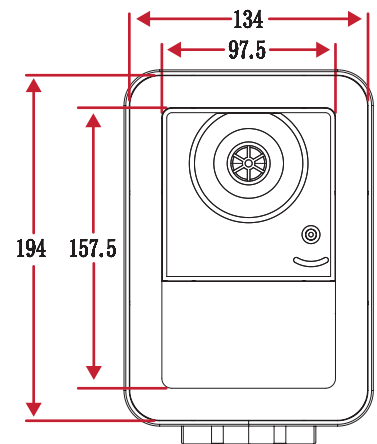
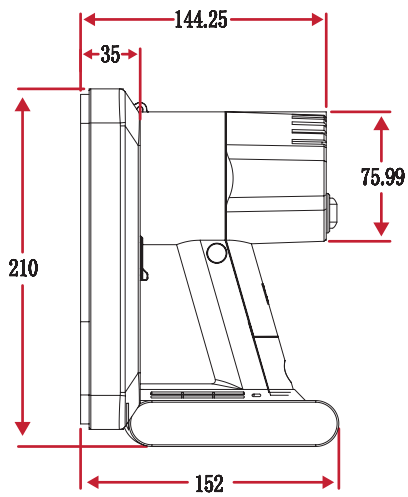
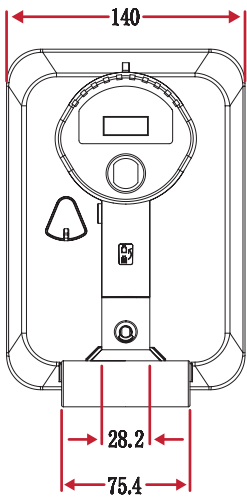
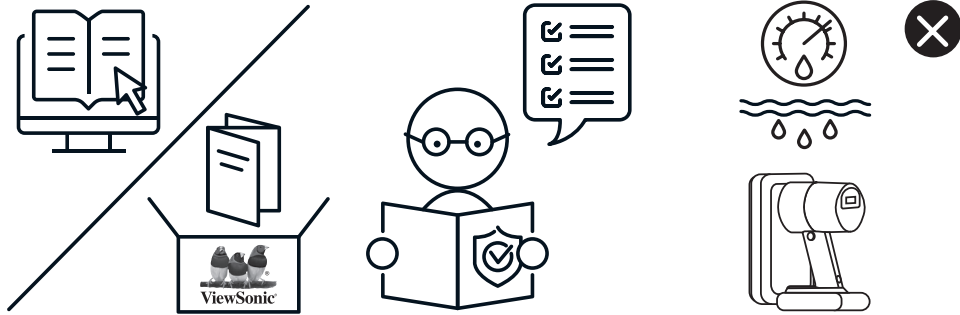

Charging the Battery

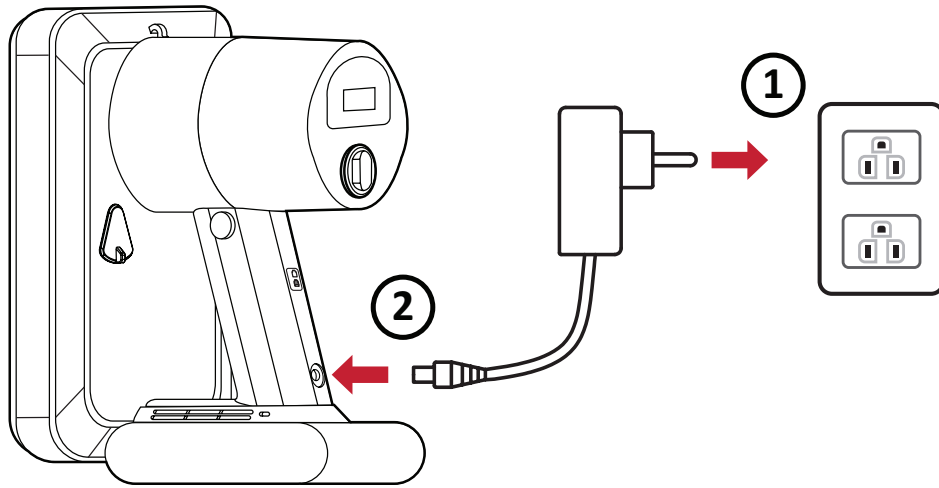

Changing the Battery

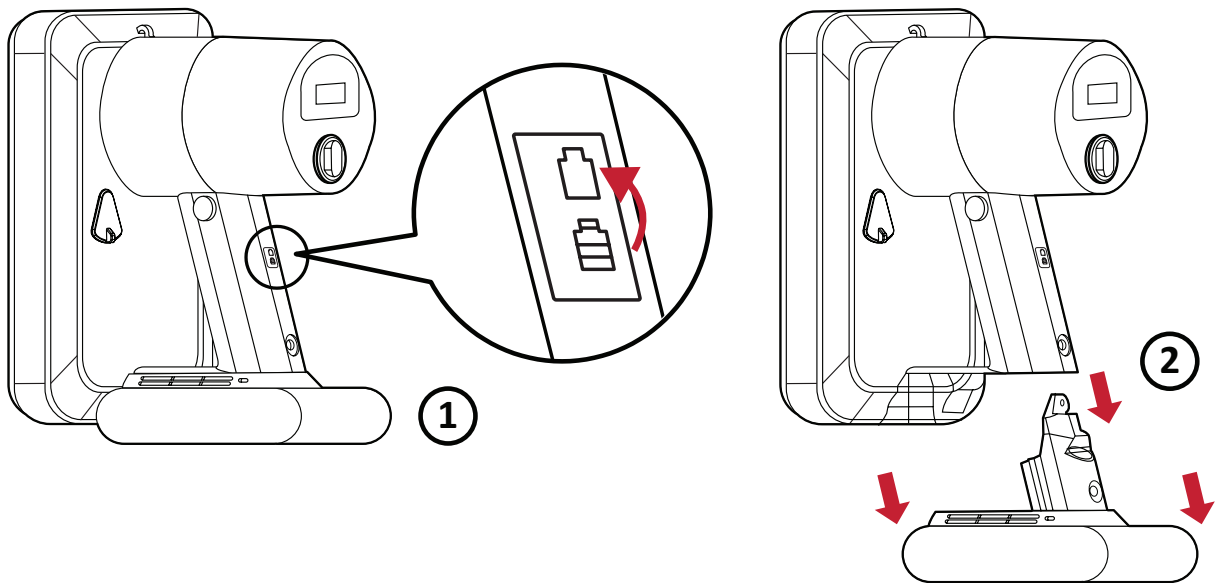

LED Module Disassembly

①

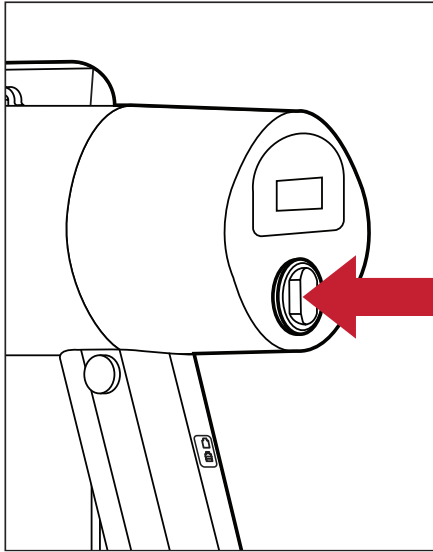

②

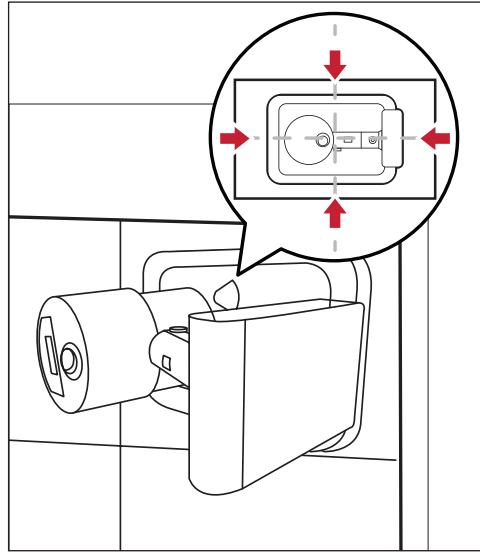

③

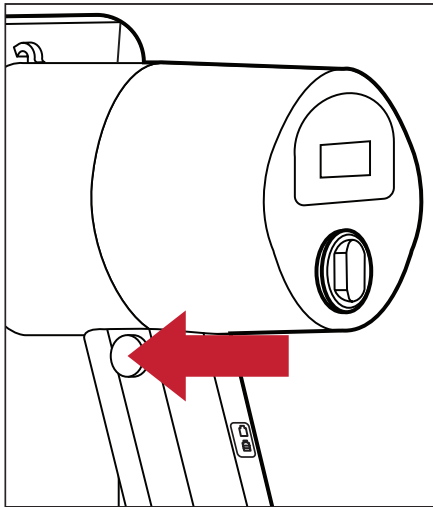

④

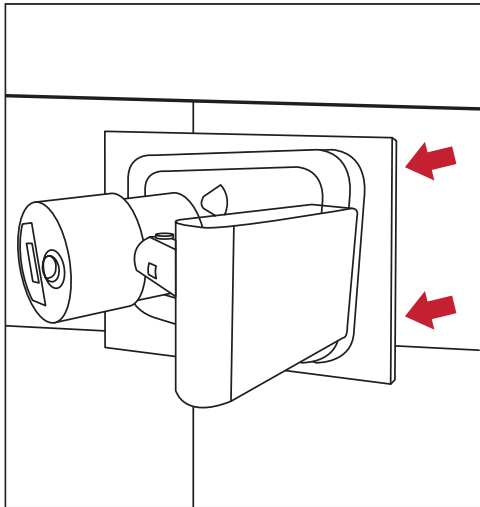

Overview

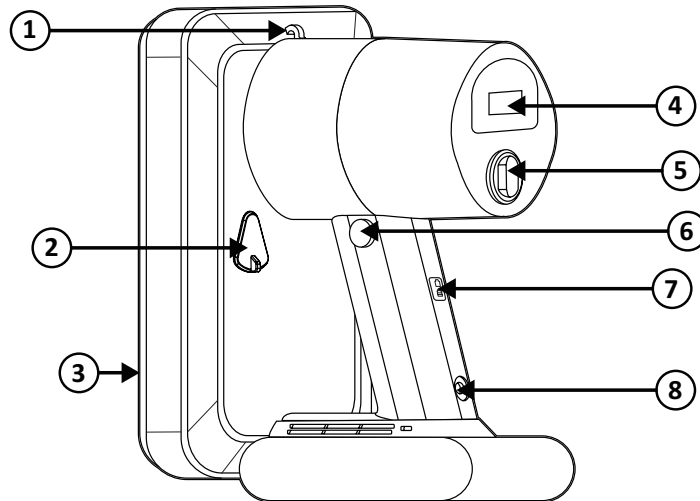

Number	Item	Description
①	Lanyard Ring	Lanyard attachment point.
②	Regulating Valve	Adjust the suction force level. Cover the valve for the strongest suction force.
③	LED Module Contact Silicone	Soft contact surface for LED module removal.
④	Power Display	Battery indicator.
⑤	Power Switch	Turn the device On/Off.
⑥	Start Button	Engage/Disengage the suction force.
⑦	Battery Removal Button	Press to remove the battery.
⑧	Charging Port	Port for battery charging.

Specifications

Item	Description
Model	LD-MK-001
Suction Face Dimension	5.27" x 7.64" (134 x 194 mm)
Available Module Size	7.56" x 7.56" to 19.69" x 19.69" (192 x 192 to 500 x 500 mm)
Product Dimension	5.98" x 5.51" x 8.27" (152 x 140 x 210 mm)
Weight	2.58 lbs. (1.17 kg)
Working Duration	17 minutes
Working Temperature	37.4° to 131° F (3° to 55° C)

RS-232 Protocol

This document describes the hardware interface and software protocols of RS-232 serial communication between the ViewSonic LED Display and computers or control systems.

RS-232 Hardware Specification

ViewSonic RS-232 serial port on the lower left side:

1. Connector type: DB 9-Pin Female
2. Use of straight-through parallel cable for connection
3. Pin Assignment:

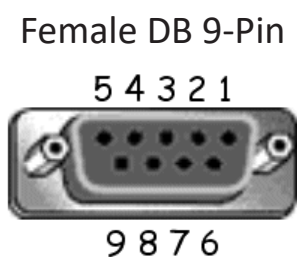

Pin #	Signal	Remark
1	NC	
2	TXD	Output from Display
3	RXD	Input to Display
4	NC	
5	GND	GND
6	NC	
7	NC	
8	NC	
9	NC	
frame	GND	

RS-232 Communication Setting

- Baud Rate Select: 115200bps (fixed)
- Data bits: 8 bits (fixed)
- Parity: None (fixed)
- Stop Bits: 1(fixed)

Command Table

Function	Command Code (Hex)	HEX	Data Range
Power On	21	38 30 31 73 21 30 30 31 0D	
Power Off (Standby)	21	38 30 31 73 21 30 30 30 0D	
Get-Power Status	6C	38 30 31 67 6C 30 30 30 0D	
Input Select: HDMI 1	22	38 30 31 73 22 30 30 34 0D	
Input Select: HDMI 2	22	38 30 31 73 22 30 31 34 0D	
Get-Input Select	6A	38 30 31 67 6A 30 30 30 0D	
Input Select: Home	22	38 30 31 73 22 30 30 41 0D	
Brightness: Down (-1)	24	38 30 31 73 24 39 30 30 0D	
Brightness: Up (+1)	24	38 30 31 73 24 39 30 31 0D	
Volume: Down (-1)	35	38 30 31 73 35 39 30 30 0D	
Volume: Up (+1)	35	38 30 31 73 35 39 30 31 0D	
Get-Volume	66	38 30 31 67 66 30 30 30 0D	
Mute: OFF	36	38 30 31 73 36 30 30 30 0D	
Mute: ON (mute)	36	38 30 31 73 36 30 30 31 0D	
Get-Mute	67	38 30 31 67 67 30 30 30 0D	
Number (0~9)	40	38 30 31 73 40 30 30 3x 0D	x = 0~9
Key Pad: UP	41	38 30 31 73 41 30 30 30 0D	
Key Pad: DOWN	41	38 30 31 73 41 30 30 31 0D	
Key Pad: LEFT	41	38 30 31 73 41 30 30 32 0D	
Key Pad: RIGHT	41	38 30 31 73 41 30 30 33 0D	
Key Pad: ENTER	41	38 30 31 73 41 30 30 34 0D	
Key Pad: INPUT	41	38 30 31 73 41 30 30 35 0D	
Key Pad: MENU	41	38 30 31 73 41 30 30 36 0D	
Key Pad: EXIT	41	38 30 31 73 41 30 30 37 0D	
Get-Operational Hours	31	38 30 31 67 31 30 30 30 0D	

Regulatory and Service Information

Compliance Information

This section addresses all connected requirements and statements regarding regulations. Confirmed corresponding applications shall refer to nameplate labels and relevant markings on the unit.

FCC Compliance Statement

This device complies with part 15 of FCC Rules. Operation is subject to the following two conditions: (1) this device may not cause harmful interference, and (2) this device must accept any interference received, including interference that may cause undesired operation. This equipment has been tested and found to comply with the limits for a Class B digital device, pursuant to part 15 of the FCC Rules.

These limits are designed to provide reasonable protection against harmful interference in a residential installation. This equipment generates, uses, and can radiate radio frequency energy, and if not installed and used in accordance with the instructions, may cause harmful interference to radio communications. However, there is no guarantee that interference will not occur in a particular installation. If this equipment does cause harmful interference to radio or television reception, which can be determined by turning the equipment off and on, the user is encouraged to try to correct the interference by one or more of the following measures:

- Reorient or relocate the receiving antenna.
- Increase the separation between the equipment and receiver.
- Connect the equipment into an outlet on a circuit different from that to which the receiver is connected.
- Consult the dealer or an experienced radio/TV technician for help.

The antenna(s) used for this transmitter must not be collocated or operating in conjunction with any other antenna or transmitter.

The device was tested and complies to measurement standards and procedures specified in FCC CFR Title 47 Part 15 Subpart C.

FCC Radiation Exposure Statement

This equipment complies with FCC radiation exposure limits set forth for an uncontrolled environment. End users must follow the specific operating instructions for satisfying RF exposure compliance.

This transmitter must not be co-located or operating in conjunction with any other antenna or transmitter. This equipment should be installed and operated with a minimum distance of 20 centimeters between the radiator and your body.

The users manual or instruction manual for an intentional or unintentional radiator shall caution the user that changes or modifications not expressly approved by the party responsible for compliance could void the user's authority to operate the equipment.

Warning: You are cautioned that changes or modifications not expressly approved by the party responsible for compliance could void your authority to operate the equipment.

IC Warning Statement

This device complies with Industry Canada license- exempt RSS standard(s). Operation is subject to the following two conditions: (1) this device may not cause interference, and (2) this device must accept any interference, including interference that may cause undesired operation of the device.

Le présent appareil est conforme aux CNR d'Industrie Canada applicables aux appareils radio exempts de licence. L'exploitation est autorisée aux deux conditions suivantes : (1) l'appareil ne doit pas produire de brouillage, et (2) l'utilisateur de l'appareil doit accepter tout brouillage radioélectrique subi, même si le brouillage est susceptible d'en compromettre le fonctionnement.

Country Code Statement

For product available in the USA/Canada market, only channel 1~11 can be operated. Selection of other channels is not possible.

Pour les produits disponibles aux États-Unis/Canada du marché, seul le canal 1 à 11 peuvent être exploités. Sélection d'autres canaux n'est pas possible.

IC Radiation Exposure Statement

This equipment complied with IC RSS-102 radiation exposure limits set forth for an uncontrolled environment. This equipment should be installed and operated with minimum distance 20cm between the radiator & your body. The device for the band 5150-5825 MHz is only for indoor usage to reduce potential for harmful interference to co-channel mobile satellite systems.

Cet équipement est conforme aux limites d'exposition aux rayonnements IC établies pour un environnement non contrôlé. Cet équipement doit être installé et utilisé avec un minimum de 20cm de distance entre la source de rayonnement et votre corps. Les dispositifs fonctionnant dans la bande 5150-5825 MHz sont réservés uniquement pour une utilisation à l'intérieur afin de réduire les risques de brouillage préjudiciable aux systèmes de satellites mobiles utilisant les mêmes canaux.

CE Conformity for European Countries

 The device complies with the EMC Directive 2014/30/EU and Low Voltage Directive 2014/35/EU.

The following information is only for EU-member states:

The mark shown to the right is in compliance with the Waste Electrical and Electronic Equipment Directive 2012/19/EU (WEEE). The mark indicates the requirement NOT to dispose of the equipment as unsorted municipal waste, but use the return and collection systems according to local law.



Declaration of RoHS2 Compliance

This product has been designed and manufactured in compliance with Directive 2011/65/EU of the European Parliament and the Council on restriction of the use of certain hazardous substances in electrical and electronic equipment (RoHS2 Directive) and is deemed to comply with the maximum concentration values issued by the European Technical Adaptation Committee (TAC) as shown below:

Substance	Proposed Maximum Concentration	Actual Concentration
Lead (Pb)	0.1%	< 0.1%
Mercury (Hg)	0.1%	< 0.1%
Cadmium (Cd)	0.01%	< 0.01%
Hexavalent Chromium (Cr6 ⁺)	0.1%	< 0.1%
Polybrominated biphenyls (PBB)	0.1%	< 0.1%
Polybrominated diphenyl ethers (PBDE)	0.1%	< 0.1%
Bis (2-ethylhexyl) phthalate (DEHP)	0.1%	< 0.1%
Butyl benzyl phthalate (BBP)	0.1%	< 0.1%
Dibutyl phthalate (DBP)	0.1%	< 0.1%
Diisobutyl phthalate (DIBP)	0.1%	< 0.1%

Certain components of products as stated above are exempted under the Annex III of the RoHS2 Directives as noted below:

- Copper alloy containing up to 4% lead by weight.
- Lead in high melting temperature type solders (i.e. lead-based alloys containing 85% by weight or more lead).
- Electrical and electronic components containing lead in a glass or ceramic other than dielectric ceramic in capacitors, e.g. piezoelectronic devices, or in a glass or ceramic matrix compound.
- Lead in dielectric ceramic in capacitors for a rated voltage of 125V AC or 250V DC or higher.

European Union Regulatory Conformance

The equipment complies with the RF Exposure Requirement 2014/53/EU, Council Recommendation of 16 April 2014 on the limitation of exposure of the general public to electromagnetic fields (0-300 GHz). This equipment meets the following conformance standards: EN301489-1, EN301489-17, EN62368-1, EN300328.

We, hereby, declare that this Wi-Fi radio is in compliance with the essential requirements and other relevant provisions of Directive 2014/53/EU.

Indian Restriction of Hazardous Substances

Restriction on Hazardous Substances statement (India). This product complies with the “India E-waste Rule 2011” and prohibits use of lead, mercury, hexavalent chromium, polybrominated biphenyls or polybrominated diphenyl ethers in concentrations exceeding 0.1 weight % and 0.01 weight % for cadmium, except for the exemptions set in Schedule 2 of the Rule.

Product Disposal at End of Product Life

ViewSonic® respects the environment and is committed to working and living green. Thank you for being part of Smarter, Greener Computing. Please visit the ViewSonic® website to learn more.

USA & Canada:

<https://www.viewsonic.com/us/company/green/go-green-with-viewsonic/#recycle-program>

Europe:

<https://www.viewsoniceurope.com/eu/support/call-desk/>

Taiwan:

<https://recycle.epa.gov.tw/>

Copyright Information

Copyright© ViewSonic® Corporation, 2022. All rights reserved.

Macintosh and Power Macintosh are registered trademarks of Apple Inc.

Microsoft, Windows, and the Windows logo are registered trademarks of Microsoft Corporation in the United States and other countries.

ViewSonic®, the three birds logo, OnView, ViewMatch, and ViewMeter are registered trademarks of ViewSonic® Corporation.

VESA is a registered trademark of the Video Electronics Standards Association. DPMS, DisplayPort, and DDC are trademarks of VESA.

CTA is a registered trademark of the Consumer Technology Association Standards.

Disclaimer: ViewSonic® Corporation shall not be liable for technical or editorial errors or omissions contained herein; nor for incidental or consequential damages resulting from furnishing this material, or the performance or use of this product.

In the interest of continuing product improvement, ViewSonic® Corporation reserves the right to change product specifications without notice. Information in this document may change without notice.

No part of this document may be copied, reproduced, or transmitted by any means, for any purpose without prior written permission from ViewSonic® Corporation.

Customer Service

For technical support or product service, see the table below or contact your reseller.

NOTE: You will need the product's serial number.

Country/ Region	Website	Country/ Region	Website
Asia Pacific & Africa			
Australia	www.viewsonic.com/au/	Bangladesh	www.viewsonic.com/bd/
中国 (China)	www.viewsonic.com.cn	香港 (繁體中文)	www.viewsonic.com/hk/
Hong Kong (English)	www.viewsonic.com/hk-en/	India	www.viewsonic.com/in/
Indonesia	www.viewsonic.com/id/	Israel	www.viewsonic.com/il/
日本 (Japan)	www.viewsonic.com/jp/	Korea	www.viewsonic.com/kr/
Malaysia	www.viewsonic.com/my/	Middle East	www.viewsonic.com/me/
Myanmar	www.viewsonic.com/mm/	Nepal	www.viewsonic.com/np/
New Zealand	www.viewsonic.com/nz/	Pakistan	www.viewsonic.com/pk/
Philippines	www.viewsonic.com/ph/	Singapore	www.viewsonic.com/sg/
臺灣 (Taiwan)	www.viewsonic.com/tw/	ประเทศไทย	www.viewsonic.com/th/
Việt Nam	www.viewsonic.com/vn/	South Africa & Mauritius	www.viewsonic.com/za/
Americas			
United States	www.viewsonic.com/us	Canada	www.viewsonic.com/us
Latin America	www.viewsonic.com/la		
Europe			
Europe	www.viewsonic.com/eu/	France	www.viewsonic.com/fr/
Deutschland	www.viewsonic.com/de/	Қазақстан	www.viewsonic.com/kz/
Россия	www.viewsonic.com/ru/	España	www.viewsonic.com/es/
Türkiye	www.viewsonic.com/tr/	Україна	www.viewsonic.com/ua/
United Kingdom	www.viewsonic.com/uk/		

Limited Warranty

ViewSonic® Commercial Display

What the warranty covers:

ViewSonic® warrants its products to be free from defects in material and workmanship during the warranty period. If a product proves to be defective in material or workmanship during the warranty period, ViewSonic® will, at its sole option, and as your sole remedy, repair or replace the product with a similar product. Replacement Product or parts may include remanufactured or refurbished parts or components. The repair or replacement unit or parts or components will be covered by the balance of the time remaining on the customer's original limited warranty and the warranty period will not be extended. ViewSonic® provides no warranty for any third-party software whether included with the product or installed by the customer, installation of any unauthorized hardware parts or components (e.g. Projector Lamps). (Please refer to: "What the warranty excludes and does not cover" section).

Who the warranty protects:

This warranty is valid only for the first consumer purchaser.

What the warranty excludes and does not cover:

- Any product on which the serial number has been defaced, modified, or removed.
- Damage, deterioration, or malfunction resulting from:
 - » Accident, misuse, neglect, fire, water, lightning, or other acts of nature, unauthorized product modification, or failure to follow instructions supplied with the product.
 - » Repair or attempted repair by anyone not authorized by ViewSonic®.
 - » Damage to or loss of any programs, data, or removable storage media.
 - » Normal wear and tear.
 - » Removal or installation of the product.
- Software or data loss occurring during repair or replacement.
- Any damage of the product due to shipment.
- Causes external to the product, such as electric power fluctuations or failure.
- Use of supplies or parts not meeting ViewSonic's specifications.
- Failure of owner to perform periodic product maintenance as stated in the User Guide.

- Any other cause which does not relate to a product defect.
- Damage caused by static (non-moving) images displayed for lengthy periods of time (also referred to as image burn-in).
- Software - Any third-party software included with the product or installed by the customer.
- Hardware/Accessories/Parts/Components – Installation of any unauthorized hardware, accessories, consumable parts or components (e.g. Projector Lamps).
- Damage to, or abuse of, the coating on the surface of the display through inappropriate cleaning as described in the product User Guide.
- Removal, installation, and set-up service charges, including wall-mounting of the product.

How to get service:

- For information about receiving service under warranty, contact ViewSonic® Customer Support (Please refer to the “Customer Service” page). You will need to provide your product’s serial number.
- To obtain warranty service, you will be required to provide: (a) the original dated sales slip, (b) your name, (c) your address, (d) a description of the problem, and (e) the serial number of the product.
- Take or ship the product, freight prepaid, in the original container to an authorized ViewSonic® service center or ViewSonic®.
- For additional information or the name of the nearest ViewSonic® service center, contact ViewSonic®.

Limitation of implied warranties:

There are no warranties, express or implied, which extend beyond the description contained herein including the implied warranty of merchantability and fitness for a particular purpose.

Exclusion of damages:

ViewSonic's liability is limited to the cost of repair or replacement of the product. ViewSonic® shall not be liable for:

- Damage to other property caused by any defects in the product, damages based upon inconvenience, loss of use of the product, loss of time, loss of profits, loss of business opportunity, loss of goodwill, interference with business relationships, or other commercial loss, even if advised of the possibility of such damages.
- Any other damages, whether incidental, consequential or otherwise.
- Any claim against the customer by any other party.
- Repair or attempted repair by anyone not authorized by ViewSonic®.

Effect of state law:

This warranty gives you specific legal rights, and you may also have other rights which vary from state to state. Some states do not allow limitations on implied warranties and/or do not allow the exclusion of incidental or consequential damages, so the above limitations and exclusions may not apply to you.

Sales outside the U.S.A. and Canada:

For warranty information and service on ViewSonic® products sold outside of the U.S.A. and Canada, contact ViewSonic® or your local ViewSonic® dealer.

The warranty period for this product in mainland China (Hong Kong, Macao, and Taiwan Excluded) is subject to the terms and conditions of the Maintenance Guarantee Card.

For users in Europe and Russia, full details of warranty provided can be found at: <http://www.viewsonic.com/eu/> under "Support/Warranty Information".

Mexico Limited Warranty

ViewSonic® Commercial Display

What the warranty covers:

ViewSonic® warrants its products to be free from defects in material and workmanship, under normal use, during the warranty period. If a product proves to be defective in material or workmanship during the warranty period, ViewSonic® will, at its sole option, repair or replace the product with a like product. Replacement product or parts may include remanufactured or refurbished parts or components & accessories.

Who the warranty protects:

This warranty is valid only for the first consumer purchaser.

What the warranty excludes and does not cover:

- Any product on which the serial number has been defaced, modified or removed.
- Damage, deterioration, or malfunction resulting from:
 - » Accident, misuse, neglect, fire, water, lightning, or other acts of nature, unauthorized product modification, unauthorized attempted repair, or failure to follow instructions supplied with the product.
 - » Causes external to the product, such as electrical power fluctuations or failure.
 - » Use of supplies or parts not meeting ViewSonic®'s specifications.
 - » Normal wear and tear.
 - » Any other cause which does not relate to a product defect.
- Any product exhibiting a condition commonly known as “image burn-in” which results when a static image is displayed on the product for an extended period of time.
- Removal, installation, insurance, and set-up service charges.

How to get service:

For information about receiving service under warranty, contact ViewSonic® Customer Support (Please refer to the attached “Customer Service” page). You will need to provide your product’s serial number, so please record the product information in the space provided below on your purchase for your future use. Please retain your receipt of proof of purchase to support your warranty claim.

For Your Records

Product Name: _____ Model Number: _____
Document Number: _____ Serial Number: _____
Purchase Date: _____ Extended Warranty Purchase? _____(Y/N)
If so, what date does warranty expire? _____

- To obtain warranty service, you will be required to provide (a) the original dated sales slip, (b) your name, (c) your address, (d) a description of the problem, and (e) the serial number of the product.
- Take or ship the product, in the original container packaging, to an authorized ViewSonic® service center.
- Round trip transportation costs for in-warranty products will be paid by ViewSonic®.

Limitation of implied warranties:

There are no warranties, express or implied, which extend beyond the description contained herein including the implied warranty of merchantability and fitness for a particular purpose.

Exclusion of damages:

ViewSonic®’s liability is limited to the cost of repair or replacement of the product. ViewSonic® shall not be liable for:

- Damage to other property caused by any defects in the product, damages based upon inconvenience, loss of use of the product, loss of time, loss of profits, loss of business opportunity, loss of goodwill, interference with business relationships, or other commercial loss, even if advised of the possibility of such damages.
- Any other damages, whether incidental, consequential or otherwise.
- Any claim against the customer by any other party.
- Repair or attempted repair by anyone not authorized by ViewSonic®.

Contact Information for Sales & Authorized Service (Centro Autorizado de Servicio) within Mexico:	
Name, address, of manufacturer and importers: México, Av. de la Palma #8 Piso 2 Despacho 203, Corporativo Interpalmas, Col. San Fernando Huixquilucan, Estado de México Tel: (55) 3605-1099 http://www.viewsonic.com/la/soporte/index.htm	
NÚMERO GRATIS DE ASISTENCIA TÉCNICA PARA TODO MÉXICO: 001.866.823.2004	
Hermosillo: Distribuciones y Servicios Computacionales SA de CV. Calle Juarez 284 local 2 Col. Bugambilias C.P: 83140 Tel: 01-66-22-14-9005 E-Mail: disc2@hmo.megared.net.mx	Villahermosa: Compumantenimientos Garantizados, S.A. de C.V. AV. GREGORIO MENDEZ #1504 COL, FLORIDA C.P. 86040 Tel: 01 (993) 3 52 00 47 / 3522074 / 3 52 20 09 E-Mail: compumantenimientos@prodigy.net.mx
Puebla, Pue. (Matriz): RENTA Y DATOS, S.A. DE C.V. Domicilio: 29 SUR 721 COL. LA PAZ 72160 PUEBLA, PUE. Tel: 01(52).222.891.55.77 CON 10 LINEAS E-Mail: datos@puebla.megared.net.mx	Veracruz, Ver.: CONEXION Y DESARROLLO, S.A DE C.V. Av. Americas # 419 ENTRE PINZÓN Y ALVARADO Fracc. Reforma C.P. 91919 Tel: 01-22-91-00-31-67 E-Mail: gacosta@qplus.com.mx
Chihuahua: Soluciones Globales en Computación C. Magisterio # 3321 Col. Magisterial Chihuahua, Chih. Tel: 4136954 E-Mail: Cefeo@soluglobales.com	Cuernavaca: Compusupport de Cuernavaca SA de CV Francisco Leyva # 178 Col. Miguel Hidalgo C.P. 62040, Cuernavaca Morelos Tel: 01 777 3180579 / 01 777 3124014 E-Mail: aquevedo@compusupportcva.com
Distrito Federal: QPLUS, S.A. de C.V. Av. Coyoacán 931 Col. Del Valle 03100, México, D.F. Tel: 01(52)55-50-00-27-35 E-Mail : gacosta@qplus.com.mx	Guadalajara, Jal.: SERVICRECE, S.A. de C.V. Av. Niños Héroes # 2281 Col. Arcos Sur, Sector Juárez 44170, Guadalajara, Jalisco Tel: 01(52)33-36-15-15-43 E-Mail: mmiranda@servicrece.com
Guerrero Acapulco: GS Computación (Grupo Sesicomp) Progreso #6-A, Colo Centro 39300 Acapulco, Guerrero Tel: 744-48-32627	Monterrey: Global Product Services Mar Caribe # 1987, Esquina con Golfo Pérsico Fracc. Bernardo Reyes, CP 64280 Monterrey N.L. México Tel: 8129-5103 E-Mail: aydeem@gps1.com.mx
MERIDA: ELECTROSER Av Reforma No. 403Gx39 y 41 Mérida, Yucatán, México CP97000 Tel: (52) 999-925-1916 E-Mail: rrrb@sureste.com	Oaxaca, Oax.: CENTRO DE DISTRIBUCION Y SERVICIO, S.A. de C.V. Murguía # 708 P.A., Col. Centro, 68000, Oaxaca Tel: 01(52)95-15-15-22-22 Fax: 01(52)95-15-13-67-00 E-Mail: gpotai2001@hotmail.com
Tijuana: STD Av Ferrocarril Sonora #3780 L-C Col 20 de Noviembr Tijuana, Mexico	FOR USA SUPPORT: ViewSonic® Corporation 381 Brea Canyon Road, Walnut, CA. 91789 USA Tel: 800-688-6688 E-Mail: http://www.viewsonic.com



ViewSonic®